

English

# OWNER'S MANUAL

Portable Micro  
Electric Motor



## PRESENTATION OF THE MANUAL

**Technical Name:** Controller For Micro Electric Motor

**Trade Name:** Portable Micro Electric Motor

**Model:** MME-11 L, MME-12 L

**Brand:** Saevo

**Technical Responsible:** Daniel R. de Camargo

CREA-SP: 5062199650

**ANVISA Registration No.:** 10101139032



Alliage S/A Industrias Médico Odontológica  
Rodovia Abrão Assed, Km 53 - CEP 14097-500  
Ribeirão Preto - SP - Brasil  
Fone: +55 (16) 3512-1212

REF

77000001439 - Rev.: 05

Document originally written in Portuguese.

### **TRADEMARKS**

All terms mentioned in this manual that are known trademarks, registered trademarks or service marks have been appropriately labeled as such. Other products, services or terms that are mentioned in this manual may be trademarks, trademarks or service marks of their respective owners. Alliage S/A makes no claims regarding these trademarks. The use of a term in this manual should not be considered to influence the validity of any trademark, trademark or service mark.

Copyright © 2019 Alliage S/A. All rights reserved.

The performance characteristics provided in this manual are for reference only and should not be considered as guaranteed specifications.

## SUMMARY

<b>1. GENERAL INFORMATION</b> .....	<b>7</b>
1.1. DEAR CUSTOMER .....	7
1.2. INDICATIONS FOR USE .....	7
1.3. CONTRAINDICATION .....	7
1.4. SIMBOLOGY .....	8
<b>2. WARNINGS, CAUTIONS AND RECOMMENDATIONS</b> .....	<b>11</b>
<b>3. SYSTEM OVERVIEW</b> .....	<b>16</b>
3.1. SYSTEM DESCRIPTION .....	16
3.2. APPLICATION SPECIFICATION .....	16
3.2.1. Operating principles .....	16
3.2.2. Significant physical characteristics .....	16
3.2.3. User profile .....	17
3.3. MAIN COMPONENTS OF THE PRODUCT .....	18
3.3.1. Controller .....	18
3.3.2. Micromotor .....	19
3.4. SETS AND ACCESSORIES .....	20
3.5. PARTS APPLIED .....	21
3.6. POSITIONING OF LABELS .....	21
3.7. SYSTEM REQUIREMENTS .....	23
3.8. INSTALLATION OF THE EQUIPMENT .....	23
<b>4. OPERATION</b> .....	<b>25</b>
4.1. INITIAL PREPARATION .....	25
4.2. OPERATION .....	27
<b>5. CLEANING, DISINFECTION AND STERILIZATION</b> .....	<b>29</b>
5.1. CONTROLLER .....	29
5.2. MICROMOTOR .....	30
<b>6. PROBLEMS DIAGNOSES</b> .....	<b>32</b>
<b>7. INSPECTION AND MAINTENANCE</b> .....	<b>34</b>
7.1. PERIODIC INSPECTION .....	34
7.2. PREVENTIVE MAINTENANCE .....	34
7.3. CORRECTIVE MAINTENANCE .....	35
7.4. ALLIAGE AUTHORIZED SERVICE NETWORK .....	36
<b>8. WARRANTY</b> .....	<b>38</b>
<b>9. STANDARDS AND REGULATIONS</b> .....	<b>40</b>
<b>10. TECHNICAL SPECIFICATIONS</b> .....	<b>42</b>
10.1. EQUIPMENT CLASSIFICATION .....	42
10.2. DEVICE INFORMATION .....	43
10.3. SPECIFIC INFORMATION .....	44
10.4. HOSE SPECIFICATIONS .....	44
10.5. ENVIRONMENTAL CONDITIONS .....	45
10.6. EQUIPMENT DIMENSIONS .....	46

**11. ELECTROMAGNETIC COMPATIBILITY . . . . . 48**  
11.1. ORIENTATION AND DECLARATION FOR ELECTROMAGNETIC EMISSIONS . . . . . 48  
11.2. ORIENTATION AND DECLARATION FOR ELECTROMAGNETIC IMMUNITY . . . . . 49

## GENERAL INFORMATION

### **1. GENERAL INFORMATION**

#### **1.1. DEAR CUSTOMER**

This manual provides you with a general presentation of your equipment, describing important details that may guide you in your correct use, as well as in solving small problems that may occur.

This manual should be read in full and kept for future reference.

#### **1.2. INDICATIONS FOR USE**

The Portable Micro Electric Motor is indicated for the treatment of:

Oral Burning Syndrome; Dental abscesses; Dental Abrasion; Periapical abscess; Periodontal abscess; Cervicofacial actinomycosis, among others in the dental area.

#### **1.3. CONTRAINDICATION**

None known.

### 1.4. SIMBOLOGY

The following symbols are used both throughout this manual and in the product. Make sure that you fully understand each symbol and follow the accompanying instructions.



Fragile, handle with care

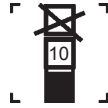

Stacking limit by number



Keep dry

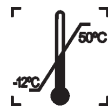

Temperature limit



This side up



Model number



Protect from sunlight



Electrostatic Sensitive Devices (ESD)



Recyclable



Manufacturer



Parts applied type B



Indicates that the product should be taken to a special garbage collection location at the end of its useful life. Applies to both the device and accessories.



# Portable Micro Electric Motor

---



Serial number



Catalog number



Sterilizable in a steam sterilizer (autoclave) at specified temperature



Model



Alternating Chain



Manufacturing Date



Attention



General warning



Mandatory action



Follow the instructions for use



Instructions for use



Type Borden Terminal



Midwest Terminal Typo



To indicate a reference to liquid spraying



Engine rotation to the left



Motor rotation to the right

## **WARNINGS, CAUTIONS AND RECOMMENDATIONS**

## 2. WARNINGS, CAUTIONS AND RECOMMENDATIONS

### General warnings



Please read and understand all instructions contained in these instructions for use before installing or operating this equipment.



Use only the equipment in perfect condition and protect yourself, patients and third parties from any hazards.



The Portable Micro Electric Motor has 3 different interactions with the user, they are:

- Identification label: Located at the bottom of the equipment;
- Safety symbols: Located at risky sites and on its identification tag;
- Central panel;

### During transport

The equipment must be transported and stored, observing the following:

- Handle with care to avoid falls, excessive vibrations and impacts;
- The packing arrows should be pointing upwards;
- To handle the package as a single unit, consider the center of gravity indicator;
- Do not stack above the quantity indicated on the package;
- Do not walk or stand above the package;
- Protect against sunlight, moisture, water and dust;
- Observe the temperature, pressure and relative humidity limits.

### During the installation of the equipment



The installation procedure must be carried out by an authorized technician.  
The installation instructions for the equipment are found in this manual.



Before turning on the equipment make sure that it is connected at the correct voltage.

- Install the equipment in a place where it will not be in contact with moisture, water, plants and animals.
- Install the equipment in a location where it will not be damaged by pressure, temperature, humidity, direct sunlight, dust, salts or corrosive products.
- This equipment is not designed for use in the presence of vapors from flammable anesthetic mixtures or nitrous oxide.
- This equipment should not be used with flammable agents or in an oxygen-rich environment.
- Place any other external devices at least 1.5 meters away from the equipment, so that the patient cannot touch any other external device while he or she is being serviced.
- The recommendations related to EMC in this manual should be followed.

Communications equipment and RF-generating sources can affect the operation of the equipment.

- Equipment may cause radio interference or interrupt the operation of nearby equipment, and it is necessary to take mitigating measures, such as reorientation, relocation of equipment or shielding of the site.

### Before using the equipment

To help ensure proper hygiene and protect against infectious diseases, prior to first use, the equipment should be cleaned, disinfected by following the instructions contained in this manual.

### When using the equipment

- Under no circumstances the patient may operate the equipment.
- The patient should not touch other parts other than those specific to be serviced.
- The equipment should be operated only by qualified health professionals.
- In order to operate the equipment, the operating personnel must:
  - Read and understand the user manual
  - Be familiar with the structure and fundamental functions of this equipment.
  - Be familiar with the emergency protocols of this equipment.
  - Be able to recognize irregularities in the operation of the equipment and implement the appropriate measures when necessary.
- The equipment is designed according to electromagnetic compatibility standards, but in very extreme conditions, it may cause interference with other equipment. Do not use this equipment in conjunction with other devices that are very sensitive to interference or with devices that create high electromagnetic disturbances.
- If this product is exposed to water, moisture or foreign substances, turn it off immediately and contact an Alliage Authorized Service Center.
- In case of damage or defect, do not use the equipment and contact an Alliage Authorized Service Center.
- Do not use the equipment if any of its compartments or parts are damaged, loose, or removed. Contact an Alliage Authorized Service Center and request repair or replacement of any damaged, loose, or removed enclosures or parts of the equipment before using the equipment again.
- Do not touch the equipment or use it if it is being repaired or if the equipment cabinets have been removed.
- Do not open or remove any of the cabinets from the equipment. No internal part can be repaired by the user.
- In case of fall or impact of moving parts causing the breakage of the same, be careful when handling them, there may be sharp parts.
- The operator cannot contact the patient when in contact with accessible connectors.
- The operator cannot use tools to open the equipment.

### Prevention against cross-contamination



Appropriate cleaning and disinfection/sterilization measures should be taken to avoid cross-contamination between patients, users and others.

- For each new patient, perform the procedures of cleaning, disinfection / sterilization and in accordance with the instructions contained in this manual.

### After use / operation of the equipment

- Turn off the equipment if not in use for too long.
- All parties that have had contact with the patient should be cleaned and disinfected/sterilized before each new patient to avoid transmission of infectious agents that may cause serious diseases.
- Clean and disinfect/sterilize as instructed in this manual.
- Do not unplug the cable or other connections without needing to.
- Do not modify this equipment without the manufacturer's permission, risk of electric shock, damage to the product, danger of loss of product operating characteristics.

### Precautions in case of change in the operation of the equipment

If the equipment has any abnormalities, check to see if the problem is related to an item listed in the "Troubleshooting" topic in this user manual.

If the problem cannot be resolved, turn off the equipment, contact an Alliage Authorized Service Center.

The manufacturer is NOT responsible for:



- The equipment is used for purposes other than those for which it was designed.
- Damage caused to the equipment, operator and/or patient as a result of incorrect installation and maintenance procedures in disagreement with the operating instructions accompanying the equipment.

### Precautions for environmental impact reduction



All environmental indications must be taken into account by the electromedical system.

Alliage S/A aims to achieve an environmental policy to promote the supply of environmentally conscious medical and dental products that continuously minimize environmental impact and are more environmentally friendly to the environment and human health.

To maintain minimal impact on the environment, please note the recommendations below:

- After installation, forward the recyclable materials to the recycling process.
- During the life cycle of the equipment, turn it off when it is not in use.
- To prevent environmental contamination, the disposal of waste and consumables must follow the normal procedure for biomedical waste.

Biomedical waste includes non-acute materials likely to cause disease or suspected of harboring pathogenic organisms that must be stored in a yellow bag properly labelled with a symbol of biological risk, stored in a puncture-resistant container, watertight, until collection and incineration.



The packaging of the equipment is composed of cardboard and polyethylene which are 100% recyclable materials.

DIMENSIONS: 390 x 340 x 110mm /MASS: About: 2,4 Kg

### Precautions in case of equipment being unused

To avoid environmental contamination or misuse of the equipment, when it is unused, it must be disposed of (according to current legislation) in an appropriate place, because the materials inside it can contaminate the environment.

For the European Economic Area (EEA), this product is subject to Directive 2012/19/EU as well as the corresponding national laws. This policy requires that the product should be taken to a special garbage collection location at the end of its useful life. Applies to both the device and accessories.

Contact the dealer if the final disposal of the product is required.



This equipment should not be disposed of as household waste.

## SYSTEM OVERVIEW

## 3. SYSTEM OVERVIEW

### 3.1. SYSTEM DESCRIPTION

The Portable Micro Electric Motor replaces the traditional Pneumatic Handpieces, significantly reduces the noise level since it does not require compressed air to generate speed that is by electromagnetic induction.

Superior to the conventional Micro Motor Pneumatic, the Portable Electric Motor offers the professional an unmatched level of accuracy, with a very high level of torque and precise control of the speed of rotation. The Portable Electric Micro Motor is the ultimate in instrument for oral preparations for you who want a work of excellence.

In addition, the Micro Portable Electric Motor virtually eliminates the infamous noise of handpieces providing more comfort for the professional and especially for their patients.

### 3.2. APPLICATION SPECIFICATION

The Portable Electric Micro Motor is intended for the removal of cavities, removal of restorations and odontosection, as an aid in the extraction of teeth, and they are for dental exclusive use, and must be handled by trained, qualified and regulated health professionals according to local legislation.

#### 3.2.1. Operating principles

The Portable Electric Micro Motor operates by electromagnetic induction and has the ISO 3964 Coupling type 3 Extra Short connection for use with the Micro Electric Motor.

The Portable Micro Motor has a micromotor and can be used with a transmission accessory. The Portable Electric Micro Motor has its specific use case, however, in general, they are a rotating instrument used to sprout typically oral bone structures.

**Micromotor:** For the micromotor to operate properly for its use, it promotes shaft rotations at the magnitude of 100 to 40,000 rotations/minute and presents a torque of 3 N.cm. Under normal operating conditions, the equipment has a compressed air consumption of > 60 L/min and a water consumption of 42 mL/min.

**Angle Transmission Accessory (AC):** For the Contra Angle to operate properly for its use, it promotes drill rotations of a maximum of 40,000 rotations/minute, and the transmission of the rotation effect is made from micromotor to counter angle on a scale of 1:5.

#### 3.2.2. Significant physical characteristics

The Portable Electric Micro Motor promotes shaft rotations at the magnitude of 100 to 40,000 rotations/minute and has maximum torque of 3 N.cm.

Net weight: 2.0 kg;

Gross weight: 2.5 kg;

Dimensions: Length 228 mm; Width 79 mm; Height 71 mm;



### 3.2.3. User profile

The Portable Electric Micro Motor can be operated and handled by users of both genders, with the ability to read and understand images, symbols, icons, Western Arabic characters (Arial font), alpha numeric characters, know how to distinguish intraoral part of the human body, and may not present a degree of visual imperfection for reading or vision and average degree of impairment of recent memory, not being in clear capacity to perform the activities and functions of the product in a correct manner the profession. The user needs to be a professional in the area of qualified health and trained with technical competence in the area of health and dentistry.

### 3.3. MAIN COMPONENTS OF THE PRODUCT

#### 3.3.1. Controller



The content of this page is informative, and the equipment may be different from the one illustrated. Therefore, when purchasing the product check the technical compatibility between the equipment, coupling and accessories.

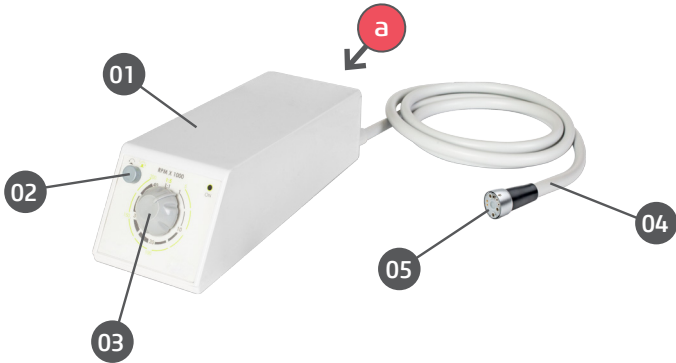

- 01 - Tabletop
- 02 - Rotation Sense Button
- 03 - Rotation Speed Adjustment Button
- 04 - Supply Hose
- 05 - Connection (fast release coupling)



Back view



- 01 - Connection Handpiece
- 02 - Connection Midwest Terminal
- 03 - Power Entrance
- 04 - Of/Off Button



#### Borden Adapter

The equipment connection is compatible with Midwest Terminal Type and it accompanies adapter for Borden Terminal.

**Incoming connection:** Type 3 (As per ISO 9168:2009)

**Inbound connection with Borden adapter:** Type 1 of 2 holes.

### 3.3.2. Micromotor

#### Model EM-12 L

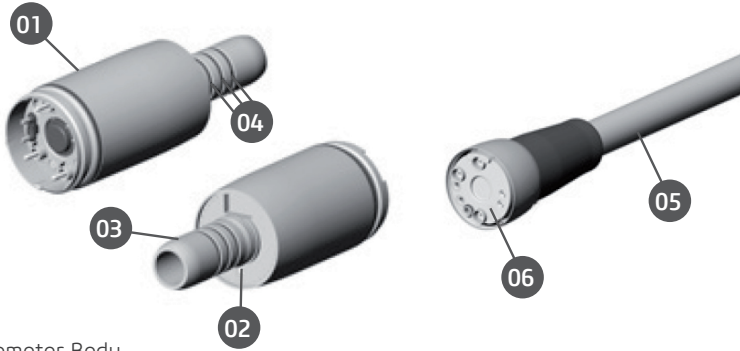

- 01 - Micromotor Body
- 02 - LED
- 03 - Connection for Tools
- 04 - Sealing Rings
- 05 - Supply Hose
- 06 - Connection (fast release coupling)

#### Model EM-11 L

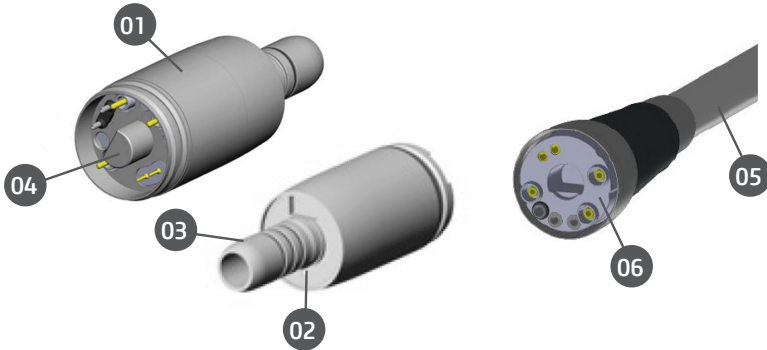

- 01 - Micromotor Body
- 02 - LED
- 03 - Connection for Tools
- 04 - Central Pin
- 05 - Supply Hose
- 06 - Connection (fast release coupling)

## 3.4. SETS AND ACCESSORIES



All parts, accessories and options described in the owner's manual are for exclusive use. The use of any parts, accessories or materials not specified in this manual is the sole responsibility of the user.

### Accessories that accompany the product

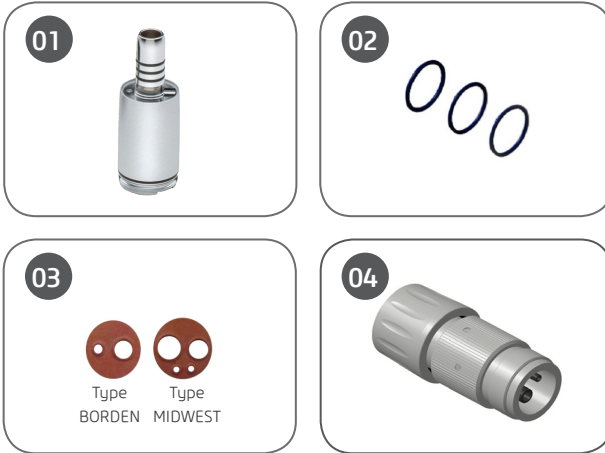

- 01 - Micromotor (EM-11 L/EM-12 L)
- 02 - Sealing Rings
- 03 - Hitch Trim (TB/TM)
- 04 - Borden Adapter

### Parts and parts accompanying the product

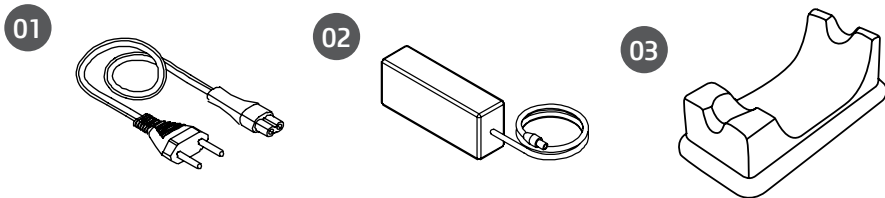

- 01 - Power Cable
- 02 - Power Supply
- 03 - Support for Micromotor

## 3.5. PARTS APPLIED

The following item is used in the treatment of the patient.

	Type of parts	Type of contact	Contact duration	Classification
Dentist Tip	Removable	Mucous Membrane/ Bone structure	<60s	Type B
Micromotor	Removable	Mucous Membrane/ Bone structure	<60s	Type B
Contra Angle	Removable	Mucous Membrane/ Bone structure	<60s	Type B





## 3.6. POSITIONING OF LABELS

The following figure illustrates the location of the labels on the equipment.



- A - Identification label
- B - Safety label
- C - Instruction manual consultation label

## Identification label

 Alliage S/A Indústrias Médico Odontológica Rod. Abrão Assed, Km 53 CEP 14097-500 Ribeirão Preto/SP - Brasil <b>MADE IN BRAZIL</b>			
<b>PRODUCT / PRODUTO</b>			
MICRO MOTOR ELÉTRICO PORTÁTIL			
MODEL			
SN	O.P		
	#		
<b>Fluxo de Ar &gt; 8 NL/min</b>			
<b>Fluxo de Água &gt; 200 mL/min</b>			
<b>POWER INPUT / POTENCIA DE ENTRADA</b>			
100 - 240 V~ 50/60 Hz 120 VA			
<b>OPERATION OPERAÇÃO</b>			
T.on: 1min / T.off: 4min			
<b>Registro ANVISA:</b>			
			

\* DEMONSTRATIVE IMAGE. REAL DIMENSIONS 100 x 63 mm

## Safety label

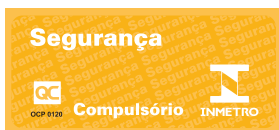

\* DEMONSTRATIVE IMAGE. REAL DIMENSIONS 50 x 23 mm

## Instruction manual consultation label



\* DEMONSTRATIVE IMAGE. REAL DIMENSIONS DIAM. 10 mm

### 3.7. SYSTEM REQUIREMENTS

The Portable Electric Micro Motor must be installed in dental equipment with the technical specifications below:

Pressure limit of 80 psi / 551,581 kpa;

Limit flow rate  $\geq 47$  NL/min;

Humidity limit between 40 and 60%;

Oil contamination limit of 0.5 mg/m<sup>3</sup>;

Particle contamination limit  $< 100$  particles/m<sup>3</sup> (size particles between 1 and 5 $\mu$ m);

Air quality regulations comply with the laws of each country.



To meet safety standards, do not operate non-medical equipment within the patient's area. Outside the patient's area, the presence of non-medical equipment is acceptable, provided approved and certified equipment is used.



There may be no connection of any component of the system with other equipment not recommended by the manufacturer.

### 3.8. INSTALLATION OF THE EQUIPMENT



Use only the equipment in perfect conditions and protect yourself, patients and third parties from any hazards.



For maximum performance, there may be a need for some adjustments in the regulation of pressure valves of the equipment, depending on the model of Dental Equipment that the Portable Electric Micro Motor is installed. If the user notices any abnormality during periodic inspection of the equipment, either in operating noise or water leakage in the spray holes, turn off the equipment and request the presence of an authorized technician.



The Portable Electric Micro Motor, depending on the dental equipment model, for ergonomics and efficiency in working mode, may need to be uninstalled when not used.

Plug the equipment into the socket using the power supply and proceed according to the following sequence of operations.

Connect the Borden or Midwest equipment hose to the portable electric micro motor.

If the equipment hose is Borden connection type use the adapter to transform the terminal of the Portable Electric Motor into Borden terminal.



The equipment should not be used at a height greater than 1 meter.

# 4

## OPERATION



## 4. OPERATION

### 4.1. INITIAL PREPARATION



The equipment should be cleaned and disinfected prior to use in a new patient, observing the instructions contained in this manual.



To insulate the power supply equipment, use the general switch.



This product does not require lubrication.

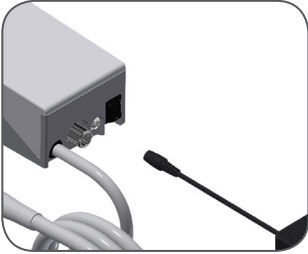

1 - Connect the power cable to the Controller and the power supply.

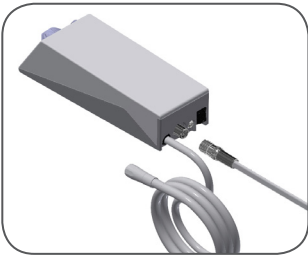

2 - Connect the supply hose of the dental unit to the Controller.  
Pay attention to positioning.

The connection of the equipment is compatible with Midwest Type Terminal and accompanies adapter to Borden Terminal.

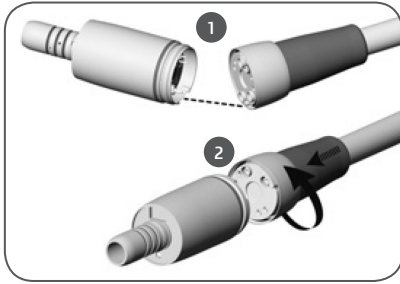

1 - Align the Micromotor connecting tubes with the supply hose connection openings.

2 - Fit the Micromotor and the supply hose together.

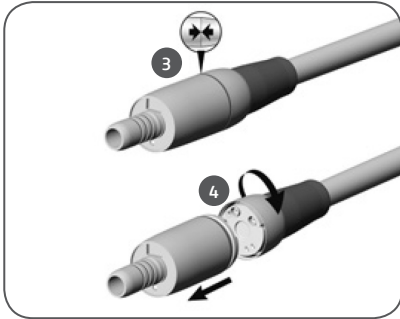

3 - Perform a visual inspection. The Micromotor and the coupling of the supply hose must be aligned with each other.

4 - After use, undock the supply hose from the micromotor.

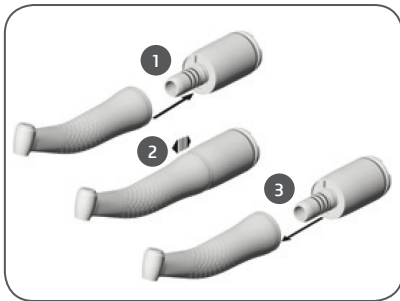

1 - Push the transmission instrument into the Micromotor and rotate it until it engages in an audible manner.

2 - Check the full lock.

3 - Remove the transmission instrument from the Micromotor.

## 4.2. OPERATION

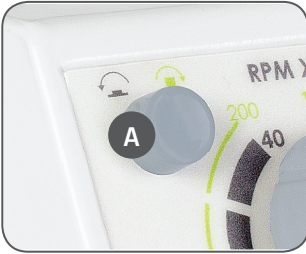

Button (A) for adjusting the direction of rotation.  
Press the button to set rotations clockwise or counterclockwise.

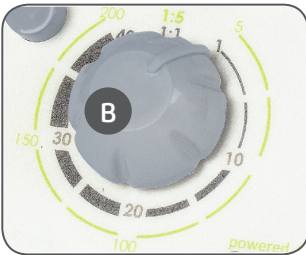

Button (B) to adjust the rotation speed.  
The Portable Electric Micro Motor promotes spindle rotations from 100 to 40,000 rotations/minute (Transmission 1:1) and 500 to 200,000 rotations/minute (1:5 transmission).

Turn on the equipment by turning the power switch on/off.

Start the Portable Micro Motor using the connected transmission instrument. Do not hold the medical device at eye level.

Activate the equip pedal to turn the Portable Micro Electric Motor on and off.



In the event of operational malfunction (e.g., vibrations, unusual noise, overheating, failure or leakage of coolant), stop the medical device immediately and contact the manufacturer.



After the end of use of the product, to finish the product, disconnect it through the master key, remove it from the outlet and undock the supply hose from the micro motor.

# 5

## CLEANING, DISINFECTION AND STERILIZATION

## 5. CLEANING, DISINFECTION AND STERILIZATION



Before starting the cleaning and disinfection procedure, turn off the equipment master key to prevent permanent damage.



For your protection, during the process of cleaning and disinfecting the equipment use PPEs as disposable gloves and goggles.

### 5.1. CONTROLLER

#### Cleaning and Disinfection

The cleaning and disinfection process should be performed with each patient change.

When starting the process, check for visible dirt, such as blood or saliva.

Carefully clean the entire contact region of the patient.

For cleaning use a clean, soft cloth dampened with mild soap and then dry with a clean, soft cloth or paper towel.

For the disinfection process of the equipment use disinfectant detergent foam that has active components based on Didecylmethylammonium chloride.

Apply the disinfectant detergent foam on the surface or on a clean cloth and spread over the surface to be treated. Respect the antimicrobial contact time indicated by the manufacturer.

After application, allow to dry. Do not rinse.

#### Cleaning the optical outlet

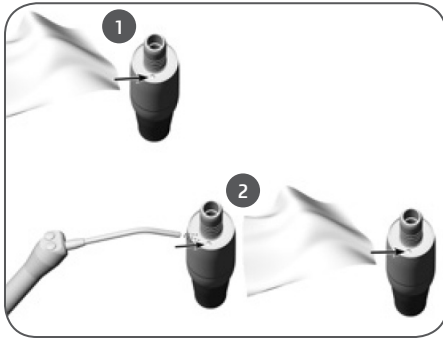

1 - Wash the optical outlet with a cleaner and a soft cloth.

2 - Blow the optical outlet with compressed air or dry it thoroughly with a soft cloth.

Perform a visual inspection after each cleaning process. Do not use the medical device if the optical outlet is damaged and contact the manufacturer.



Avoid scratching the optical outlet.

### 5.2. MICROMOTOR

#### Cleaning and Sterilization

The cleaning and disinfection process should be performed with each patient change.

When starting the process, check for visible dirt, such as blood or saliva.

Carefully clean the entire region with patient contact.

For cleaning use a clean, soft cloth dampened with mild soap and then dry with a clean, soft cloth or paper towel.

Some of the removable parts that come into contact with the patient may be autoclaved.

These parts are: Micromotor (EM-12L/EM-11L), Micromotor Support.

**135°C**



All parts and accessories suitable for sterilization must be sterilized in autoclave at 135° C with at least 3 minutes of standby time and pressure of 2.2 bar.

If these items are autoclaved, disinfection by alternative methods is not necessary.

There is no limit of cycles or application time that the equipment and its parts can tolerate during the cleaning, disinfection and/or sterilization process, following the instructions in this manual.



Store sterile products dust-free and dry.

The shelf life of sterile products depends on storage conditions and type of packaging.



Do not spill on the disinfectant liquid equipment.



Do not use organic solvents, for example, thinner, to clean the equipment.

In case the revelation solution is poured into the panel, clean immediately, as these solutions may compromise the painting of the equipment.



Sterilization parameters should always be following.

Accessories that are not sterilized properly can cause diseases in patients.

# 6

## PROBLEMS DIAGNOSES

## 6. PROBLEMS DIAGNOSES

Occasionally, malfunction may occur during use. In the event of an error, restart the equipment and resume operation. If the problem persists, follow the instructions below.

FAILURES	POSSIBLE CAUSES	SOLUTIONS
- Out-of-service Equipment.	- Power supply disconnected.	- Connect the plug into the outlet.
- There's no water in the micromotor.	- Inadequate water supply pressure. - Bad regulation of the water flow.	- Correct the water pressure. - Adjust the water flow through water register of the equipment.

If the problems persist, please contact the Alliage Service Department.



# 7

## INSPECTION AND MAINTENANCE

## 7. INSPECTION AND MAINTENANCE



Correction, preventive or assistance maintenance procedures can only be performed by technical service authorized by the manufacturer.  
The micromotor must not be disassembled or repaired in the field.

All instructions for using the equipment as intended are provided in this user guide.  
If any issues are detected and cannot be fixed with the instructions in the Troubleshooting section, contact the Alliage Service Department.

### 7.1. PERIODIC INSPECTION

It is imperative that this equipment be inspected regularly to ensure operational safety and functional reliability. This inspection should be done by personnel familiar with the necessary precautions to avoid exposing the patient to risk.

Periodic inspection should be carried out at regular intervals (at least once a year) to ensure that the product is permanently safe and operational. All components subject to normal wear and tear should be checked and, if necessary, replaced.

The manufacturer and the assembler/installer are exempt from liability that the standard results are not compliant in cases where the user does not perform the maintenance recommended by the manufacturer.

Neither inspection nor service is part of the equipment warranty.

The maintenance carried out must be documented and maintained with the equipment.

The following table gives a description of the main inspection items and recommended frequency.

ITEM	DESCRIPTION OF THE INSPECTION	RECOMMENDED FREQUENCY
Operation / Security System	Pedal drive, micromotor power, water flow, airflow (Auditory and visual).	Daily
Electrical parts	Overheating/Noise/Smell of burned (Auditory and visual).	Monthly
Parts and pieces	Operation/Noise/Vibration (Auditory and Visual).	Annual

### 7.2. PREVENTIVE MAINTENANCE

In addition to the annual inspection, to ensure a long durability and proper operation of your equipment, it is important to perform preventive maintenance in a maximum period of three (3) years.

Contact the Alliage Service Department about our periodic review and preventive maintenance program.

### 7.3. CORRECTIVE MAINTENANCE



Corrective maintenance that can be performed by the user on the Portable Electric Micro Motor is limited to the replacement of the sealing rings.



Do not open the equipment or try to fix it yourself or with the help of someone without training or authorization. This can aggravate the problem or produce a failure that may compromise the safety of the equipment.



Power cables and electronic boards can be changed only by the authorized technician.



The equipment or any of its parts may not be repaired, maintained, or assisted while being used on a patient.



The service manual is only available for Authorized Technical Assistance.

Alliage declares that the provision of circuit diagrams, component lists or any other information that provides technical assistance on behalf of the user may be requested provided that previously agreed between the user and Alliage.

The warranty will be void if the original parts are removed/replaced by unauthorized service technicians.

#### • Replacement of sealing rings



Damaged or leaky sealing rings should be changed immediately.

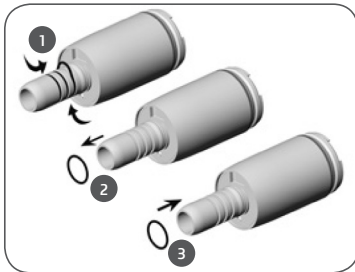

1 - To remove the sealing ring, tighten the ring between the thumb and forefinger to form a loop, or use a 1.2mm screwdriver on the ring channels by shifting them out.

2 - Remove the sealing rings.

3 - Insert the new sealing rings.

Always change all three seal rings at the same time to ensure the water tightness of the Micro Motor.

### 7.4. ALLIAGE AUTHORIZED SERVICE NETWORK

All services performed on the Alliage equipment must be performed by an Authorized Technical Assistant, as otherwise they will not be covered by the warranty.

If you need to request electrical schematics and or specification of components that are not stated in the user manual use Alliage Customer Service to make the request.

Phone: +55 (16) 3512-1212

Address: Rodovia Abrão Assed, Km 53 - Recreio Anhangüera – Ribeirão Preto-SP/ Brazil CEP 14097-500.

# 8

## WARRANTY

## **8. WARRANTY**

This equipment is covered by the warranty periods, terms and conditions contained in the Warranty Certificate that comes with the product.

# 9

## STANDARDS AND REGULATIONS

## 9. STANDARDS AND REGULATIONS

This equipment has been designed and manufactured to meet the following standards:

ABNT NBR IEC 60601-1:2010 Amendment 1:2016	Medical Electrical Equipment - Part 1: General requirements for basic security and essential performance.
ABNT NBR IEC 60601-1-2:2017	Medical Electrical Equipment, Part 1-2: General basic safety requirements and essential performance - Collateral standard: Electromagnetic Interference - Requirements and tests.
ABNT NBR IEC 80601-2-60:2015	General requirements for basic safety and essential performance of dental equipment
ABNT NBR 60601-1-6:2011	Electromedical Equipment - Part 1-6: General requirements for basic security and essential performance - Collateral standard: Usability;
ABNT NBR IEC 62366:2010	Health products - Application of usability engineering to health products;
IEC 60601-1-9:2010+AMD1:2014	Medical electrical equipment - Part 1-9: General requirements for basic security and essential performance - Collateral standard: Requirements for environmentally conscious design
IEC 62304:2006	Medical Device Software - Software Lifecycle Processes.
ISO 10993-1:2018	Biological evaluation of medical devices - Part 1: Evaluation and testing.
ISO 14457:2012	Dentistry - Handpieces and motors
ABNT NBR ISO 14971:2009	Medical devices - Application of risk management to medical devices.
ABNT NBR ISO 13485:2016	Quality management systems - Requirements for regulatory purposes



# 10

## TECHNICAL SPECIFICATIONS

## 10. TECHNICAL SPECIFICATIONS

### 10.1. EQUIPMENT CLASSIFICATION

#### EQUIPMENT CLASSIFICATION

Framing class according to ANVISA	Class II
-----------------------------------	----------

---

#### EQUIPMENT CLASSIFICATION ACCORDING TO THE STANDARD EN IEC 60601-1

Product classification for applied parts	Type B
--	--------

---

Electric Shock Protection	Class II
---------------------------	----------

---

Protection Against Harmful Water Penetration	<b>Portable Micro Electric Motor</b> IP00 - Product not protected against harmful penetration of water and particulate matter
--	--

---

Degree of safety of application in the presence of a flammable anesthetic mixture with air, oxygen or nitrous oxide	Equipment not suitable
---	------------------------

---

Operation Mode	Non-continuous operation Ton: 1 min. / Toff: 4 min.
----------------	--

---

As ABNT NBR IEC 80601-2-60:2015 – This product does not have essential performance.

---



The product must not be installed in an emergency location.

### 10.2. DEVICE INFORMATION

GENERAL INFORMATION	
Connection to proper power supply network	External power supply
Network voltage	100-240 V~ (Bivolt)
Current	1,5 A
Power	30 – 32 Vcc
Power network frequency	50 / 60 Hz
Permissible fluctuation	+/- 10 %
Number of phases	Biphasic
Master key	<b>Contact resistance:</b> maximum of 20 milliohms with application of 1A in VCC; <b>Electrical characteristics:</b> 10A / 120 VAC; <b>Insulation resistance:</b> minimum of 1,000 mega ohms;
Power consumption (VA)	120 VA - Momentary
Power consumption (W)	102 W - Momentary
Maximum network impedance	0,2Ω
Net weight	
	Portable Micro Electric Motor
	2,0 kg
Gross weight	
	Portable Micro Electric Motor
	2,5 kg
Direction of rotation	Forward or reverse
Speed range	100 – 40.000 rpm
Maximum torque in the engine	3 Ncm
Air cooling adjustment	6 – 8 NL/min
Air coolant pressure. The pressure of the air coolant must be higher than the pressure of the water coolant	0,5 – 3,0 bar
Coolant volume to (0,5 bar)	> 60 mL/min
Water cooling liquid pressure. (Adjust the actual pressure with an accessory in place).	0,5 – 3,0 bar

### 10.3. SPECIFIC INFORMATION

SPECIFIC INFORMATION		
Product Model	MME-12L	MME-11L
Micromotor Model/Brand	EM-12L/W&H	EM-11L/W&H
Forced air pressure	3 ±0,3bar	
Air consumption	> 60 L/min	
Water consumption	> 42 mL/min	
Water pressure	5100 to 30600 mmH2O	
Chip air pressure	0,5 to 3 bar	
Power connection	ISO 9168	
Chemical composition of the refrigeration liquid	H <sub>2</sub> O	

### 10.4. HOSE SPECIFICATIONS

SPECIFICATIONS OF THE PORTABLE MICRO ELECTRIC MOTOR		
Product Model	MME-12L	MME-11L
Hose Model	VE-10	VE-11
Connection Feature	Central Pin	-
Conducts cooling air at 250 kPa (2.5 bar)	> 8 NL/min	> 8 NL/min
Sprays air at 250 kPa (2.5 bar)	> 8 NL/min	> 8 NL/min
Sprays water at 200 kPa (2.0 bar)	> 200 mL/min	> 200 mL/min
Maximum pressure	500 kPa (5.0 bar)	500 kPa (5.0 bar)

### 10.5. ENVIRONMENTAL CONDITIONS

#### ENVIRONMENTAL CONDITIONS OF TRANSPORT AND STORAGE

Transport or storage room temperature range	-12°C to +50°C
Relative humidity range of transport and storage	8% to 80% RH

#### ENVIRONMENTAL CONDITIONS OF INSTALLATION AND OPERATION

Operating ambient temperature range	+10°C to +35°C
Recommended room temperature range	+21°C to +26°C
Operating relative humidity range (not condensed)	15% to 80% RH
Operating altitude	≤ 2000 m

### 10.6. EQUIPMENT DIMENSIONS

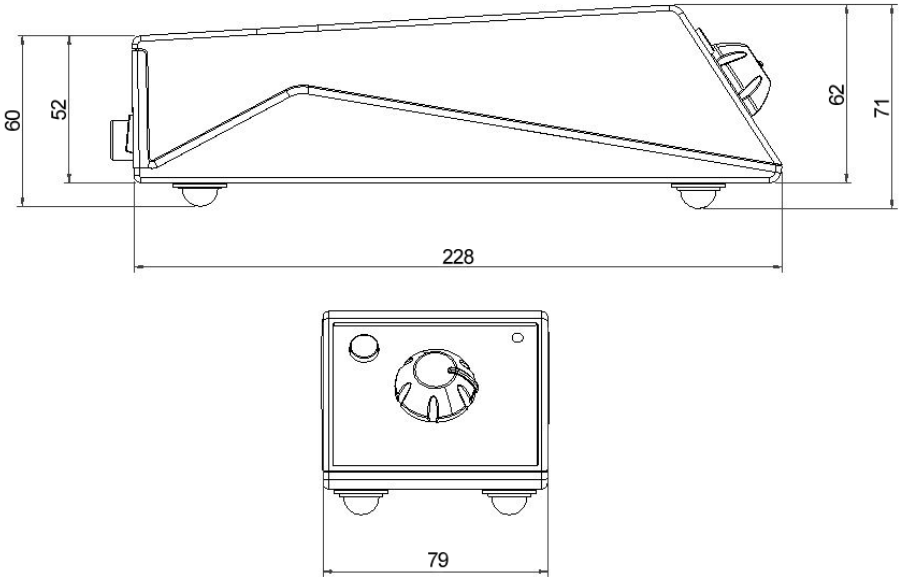

## ELECTROMAGNETIC COMPATIBILITY

## 11. ELECTROMAGNETIC COMPATIBILITY

The **Portable Micro Electric Motor** is intended for use in the electromagnetic environment specified below. It is advisable that the buyer or user ensure that it is used in such an environment.

The **Portable Micro Electric Motor** is suitable for use in a professional healthcare environment, not including areas where there are sensitive equipment or sources of intense electromagnetic disturbances, such as the RF-shielded room of a system for magnetic resonance imaging, in operating rooms near active PA surgical equipment, electrophysiology laboratories, armored rooms, or areas where shortwave therapy equipment is used.

The following tables provide equipment compliance information at ABNT NBR IEC 60601-1-2:2017.

### 11.1. ORIENTATION AND DECLARATION FOR ELECTROMAGNETIC EMISSIONS

EMISSIONS TESTS	COMPLIANCE	ELECTROMAGNETIC ENVIRONMENTS - GUIDELINES
RF emissions CISPR 11	Group 1	The <b>Portable Micro Electric Motor</b> use RF energy only for their internal functions. Therefore, its RF emissions are extremely low and are unlikely to cause any interference in nearby electronic equipment.
RF emissions CISPR 11	Class A	The <b>Portable Micro Electric Motor</b> are suitable for use in all establishments, except domestic ones and those directly connected to the public low voltage power supply network that powers buildings used for domestic purposes.
Harmonic emissions IEC 61000-3-2	Class A	
Voltage fluctuation / Scintillation emissions IEC 61000-3-3	Compliant	
<p><b>Note:</b> The emission characteristics of this equipment make it suitable for use in industrial areas and hospitals (IEC / CISPR 11, Class A). If used in a residential environment (for which IEC / CISPR 11, Class B is normally required), this equipment may not provide adequate protection for radio frequency communication services. The user may need to take mitigation measures, such as relocating or redirecting equipment.</p>		



## 11.2. ORIENTAÇÃO E DECLARAÇÃO PARA IMUNIDADE ELETROMAGNÉTICA

PHENOMENON	BASIC EMC STANDARD OR TEST METHOD	IMMUNITY TEST LEVEL	COMPLIANCE LEVEL
Electrostatic discharge	IEC 61000-4-2	± 8 kV contact ± 2 kV, ± 4 kV, ± 8 kV, ± 15 kV air	± 8 kV contact ± 2 kV, ± 4 kV, ± 8 kV, ± 15 kV air
EM fields of radiated RF	IEC 61000-4-3	3 V / m 80 MHz - 2.7 GHz 80% AM at 1 kHz	3 V / m 80 MHz - 2.7 GHz 80% AM at 1 kHz
Fields in the vicinity from RF wireless communications equipment	IEC 61000-4-3	See table	See table
Fast / saved electrical transients	IEC 61000-4-4 alternating current power input	± 2 kV 100 kHz repetition frequency	± 2 kV 100 kHz repetition frequency
Outbreak Line by line	IEC 61000-4-5	± 0,5 kV, ± 1 kV	± 0,5 kV, ± 1 kV
Conducted disorders induced by RF fields	IEC 61000-4-6	3 V 0.15 MHz - 80 MHz 6V in ISM bands between 0.15 MHz and 80 MHz 80% AM at 1 kHz	3 V 0.15 MHz - 80 MHz 6V in ISM bands between 0.15 MHz and 80 MHz 80% AM at 1 kHz
Magnetic fields at the stated feed frequency	IEC 61000-4-8	30 A/m 60 Hz	30 A/m 60 Hz
Voltage drops	IEC 61000-4-11	0 % UT; 0,5 cycle  A 0°, 45°, 90°, 135°, 180°, 225°, 270° and 315°  0 % UT; 1 cycle e 70 % UT; 25/30 cycle Single phase: a 0°	0 % UT; 0,5 cycle  A 0°, 45°, 90°, 135°, 180°, 225°, 270° and 315°  0 % UT; 1 cycle e 70 % UT; 25/30 cycle Single phase: a 0°
Voltage interruptions	IEC 61000-4-11	0 % UT; 250/300 cycles	The device will shut down and / or reset if the power is interrupted for five seconds.
<p>NOTE 1 At 80 MHz and 800MHz, the higher frequency range is applicable.                      NOTE 2 These guidelines may not apply in all situations. Electromagnetic propagation is affected by absorption and reflection from structures, objects and people.                      NOTE 3 UT is the AC mains voltage before applying the test level.</p>			

PROXIMITY FIELDS FROM WIRELESS RF COMMUNICATIONS EQUIPMENT						
TEST FREQUENCY (MHZ)	BAND (MHZ)	SERVICE	MODULATION	MAXIMUM POWER (W)	DISTANCE (M)	IMMUNITY TEST LEVEL (V/M)
385	380-390	TETRA 400	18Hz pulse modulation	1.8	0.3	27
450	430-470	GMRS 460,FRS 460	FM deviation of $\pm 5$ kHz 1kHz sinusoidal	2	0.3	28
710	704-787	Band LTE 13, 17	217 Hz pulse modulation	0.2	0.3	9
745						
7480						
810	800-960	GSM 800/900, TETRA 800, iDEN 820, CDMA 850, Band LTE 5	18Hz pulse modulation	2	0.3	28
870						
930						
1720	1700 -1990	GSM 1800; CDMA 1900; GSM 1900; DECT; Band LTE 1, 3, 4, 25; UMTS	217 Hz pulse modulation	2	0.3	28
1845						
1970						
2450	2400-2570	Bluetooth, WLAN 802.11 b/g/n, RFID 2450, Band LTE 7	217 Hz pulse modulation	2	0.3	28
5240	5100 - 5800	WLAN 802.11 a/n	217 Hz pulse modulation	0.2	0.3	9
5500						
5785						

## Portable Micro Electric Motor

---

LIST OF USED CABLES		
CABLES	DESCRIPTION	LENGTH
Power	PP Light Plane 300/300V. Nominal section: 2x0.75mm <sup>2</sup>	1.8 m



The Portable Micro Electric Motor is intended to assist the health professional, and it is for dental use only. In case of EMC disturbances, the operator may experience loss of communication between the equipment and controls.



Compliance with EMC and EMI standards cannot be guaranteed by the use of altered cables or cables that do not meet the same standards as the equipment has been validated.



The use of this equipment adjacent to other equipment should be avoided as this may result in improper operation. If this use is necessary, it is advisable that this and other equipment be observed to verify that they are operating normally.



Do not use accessories, transducers, internal parts of components and other cables other than those previously specified by the manufacturer. This may result in increased emission or decreased electromagnetic immunity, resulting in improper operation.



Portable RF communication equipment (including peripherals such as antenna cables and external antennas) should not be used less than 30 cm from any part of the Portable Micro Electric Motor, including cables specified by the manufacturer. Otherwise, performance degradation of this equipment may occur.



To maintain basic safety against electromagnetic disturbances during the expected service life, always use the equipment in the specified electromagnetic environment and follow the maintenance recommendation described in this manual.



Pins, connector sockets, or elements bearing the ESD warning symbol must not be touched or interconnected without ESD protection measures.

NUM. REG. ANVISA: 10101139032



[www.saevo.com.br](http://www.saevo.com.br)

uma marca  
**alliage**