

English

**OWNER'S
MANUAL**
NEW VERSA
DENTAL CHAIR



MANUAL PRESENTATION

Technical Name: Dental Chairs

Trade Name: Dental Chairs

Models: New Versa

Brand: Saevo

Technical Responsible: Daniel R. de Camargo

CREA-SP: 5062199650

ANVISA Registration nº: 10069210062



Alliage S/A Industrias Médico Odontológica
Rodovia Abrão Assed, Km 53 + 450m - CEP 14097-500
Ribeirão Preto - SP - Brazil
Phone: +55 (16) 3512-1212



CINTERQUAL – Soluções de Comércio
Internacional, Lda.

Avenida Defensores de Chaves, Nº 4
Escritório Idea Spaces
1000-117 Lisboa, Portugal



77000001738 - Rev.: 05 - November/22

Document originally written in Portuguese.

TRADEMARKS

All terms mentioned in this manual that are known trademarks, registered trademarks or service marks have been appropriately labeled as such. Other products, services or terms that are mentioned in this manual may be trademarks, registered trademarks or service marks of their respective owners. Alliage S / A makes no claims regarding these trademarks. The use of a term in this manual should not be considered to influence the validity of any trademark, registered trademark or service mark.

Copyright © 2019 Alliage S/A. All rights reserved.

The performance characteristics provided in this manual are for reference only and should not be considered as guaranteed specifications.

SUMMARY

1. GENERAL INFORMATION	7
1.1. DEAR CUSTOMER	7
1.2. INDICATIONS FOR USE	7
1.3. CONTRAINDICATIONS	7
1.4. SYMBOLOGY	8
2. WARNINGS, CAUTIONS AND RECOMMENDATIONS	13
3. SYSTEM OVERVIEW	18
3.1. SYSTEM DESCRIPTION	18
3.2. APPLICATION SPECIFICATION	18
3.2.1. Principles of operation	18
3.2.2. Significant physical characteristics	18
3.2.3. User profile	18
3.3. MAIN PRODUCT COMPONENTS	19
3.3.1. Chair	19
3.3.2. Accessories	20
3.4. APPLIED PARTS	23
3.5. USER INTERFACE	23
3.5.1. Integrated pedal control panel - Chip Blower	23
3.5.2. Three-Key Pedal Control Panel	26
3.5.3. Five-Key Pedal Control Panel	27
3.5.4. Seven-Key Pedal Control Panel	29
3.5.5. Pedal control panel with seven-key Joystick	30
3.5.6. Eleven-key pedal control panel	32
3.5.7. Massager control	34
3.5.8. Emergency stop button	35
3.6. LABEL POSITIONING	35
3.7. SYSTEM REQUIREMENTS	36
3.7.1. Compressor requirements	36
3.7.2. Vacuum pump requirements	36
3.7.3. Installation location	37
3.8. SYSTEM ARRANGEMENT	38
4. OPERATION	40
4.1. INITIAL PREPARATION	40
4.2. MASSAGER CONTROL FUNCTIONS	42
4.2.1. WAVE MODE	42
4.2.2. CONTINUOUS MODE	42
4.2.3. PULSE MODE	42
4.3. VOICE MODULE	43
5. CLEANING, DISINFECTION AND STERILIZATION	48
6. TROUBLESHOOTING	50
6.1. PROBLEMS SOLUTION	50
7. INSPECTION AND MAINTENANCE	53
7.1. PERIODIC INSPECTION	53
7.2. PREVENTIVE MAINTENANCE	53
7.3. CORRECTIVE MAINTENANCE	54

7.4. ALLIAGE AUTHORIZED SERVICE NETWORK	54
8. WARRANTY	56
9. STANDARDS AND REGULATIONS	58
10. TECHNICAL SPECIFICATIONS	60
10.1.EQUIPMENT CLASSIFICATION	60
10.2.APPLIANCE INFORMATION	61
10.3.ENVIRONMENTAL CONDITIONS	61
10.4.CHAIR DIMENSIONS	62
11. ELECTROMAGNETIC COMPATIBILITY	64
11.1.GUIDANCE AND DECLARATION FOR ELECTROMAGNETIC EMISSIONS	64
11.2.ORIENTATION AND DECLARATION FOR ELECTROMAGNETIC IMMUNITY	65

GENERAL INFORMATION

1.GENERAL INFORMATION

1.1.DEAR CUSTOMER

Congratulations on your excellent choice. When you buy ALLIAGE quality equipment, you can be sure of purchasing products with technology compatible with the best in the world in their class. This manual provides you with a general presentation of your equipment, describing important details that can guide you in its correct use, as well as in solving small problems that may eventually occur. This manual must be read in full and kept for future reference.

1.2.INDICATIONS FOR USE

Dental Chairs are intended to assist in the treatment and removal of caries, removal of restorations and odontosection, as an aid in tooth extraction, also indicated for burning mouth syndrome, dental abscesses, dental aberration, among others related to dental treatment.

1.3.CONTRAINDICATIONS

There are no known contraindications for this equipment.

1.4.SYMBOLGY

The following symbols are used both throughout this manual and on the product. Make sure you fully understand each symbol and follow the instructions that come with it.



Fragile, handle with care



Maximum stacking



Protect from rain

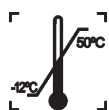

Temperature limit



This side Up



Gravity center



Protect from sunlight



Don't step



Recyclable



Authorized representative in the European community



Type B applied parts



Indicates that the product must be taken to a special waste collection site at the end of its useful life. Applies to both the device and accessories.



Protective ground wire



Electrostatic sensitive devices (ESD)

L1

Phase 1 conductor



Dangerous voltage



Alternating current

L2/N

Biphasic Configuration:
Phase 2 conductor
Single-phase configuration:
Neutral Phase



Turn off
(Power: Disconnects from the main switch)



Fuse



Turn on
(Power: Connects from the main switch)



Mandatory action



Emergency stop



Follow the instructions for use



Attention.



General warning.



Indicates that the equipment complies with Directives 2011/65 / EU and 2015/863 / EU on the Restriction on the use of certain hazardous substances in electrical and electronic equipment.



Warning;
High voltage



It determines the positions of work "1, 2 and 3".



It determines the positions of work "3 and 4".



It raises the seat



It lowers the seat



It lowers the backrest



It raises the backrest



It goes back to zero



It raises the backrest



Reflector activation



Selection - Massager



Reversing the direction of rotation of the electric micromotor



Control + or - Speed / Intensity - Massager



Stop motion



Speed / Intensity
- Massager



Zona1 / 2 - Massager



Massage area



Spray cooling



On / Off - Massager



Wi-fi



Voice command



Movable parts
can cut or crush.



Catalog number



Serial number



Model



Model number



Manufacturer



Manufacturing date

2

WARNINGS, CAUTIONS AND RECOMMENDATIONS

2. WARNINGS, CAUTIONS AND RECOMMENDATIONS

General warnings



Read and understand all instructions contained in these instructions for use before installing or operating this equipment.



Use only the equipment in perfect condition and protect yourself, patients and others against possible dangers.



This equipment must be installed and operated by personnel familiar with the necessary precautions.



The Dental Chair has 6 different interactions with the user, they are:

- Identification label: Located on the side of the equipment;
- Safety symbols: Located at risk locations and on their identification tag;
- General key: located on the side of the equipment;
- Control pedal: located close to the equipment;
- Massager control: located on the left side of the seat;
- Emergency button: located on the side of the equipment.

During transportation



All environmental indications of transport and storage must be considered by the electromedical system.

The equipment must be transported and stored, observing the following:

- Handle with care to avoid falls, excessive vibrations and impacts;
- The arrows on the packaging must be pointing upwards;
- To handle the package as a single unit, consider the center of gravity indicator;
- Do not stack above the quantity indicated on the packaging;
- Do not walk or stand above the package
- Protect against sunlight, moisture, water and dust;
- Observe the temperature, pressure and relative humidity limits.

During the installation of the equipment



Installation instructions can be found in the service manual, accessible only to authorized technicians.



The equipment is configured for mains voltage during the installation of the equipment only by the authorized technician.
This is a technical procedure that cannot be performed by the user.



The equipment must be correctly attached in accordance with the service manual and must not be subject to an inclination greater than 10 °. Risk of tipping.



To avoid the risk of electric shock, this equipment must only be connected to a mains supply with a protective ground.



For single-phase installation, the F1 fuse must be replaced by the metal pin provided to eliminate the neutral conductor fuse.



Before turning on the equipment, make sure that it is connected to the correct voltage.

- The equipment must be installed only by authorized technical assistants.
- The service manual's recommendations regarding the mandatory existence of protective earth must be followed.
- The recommendations in the service manual regarding the mandatory existence of a protective circuit breaker must be followed.
- Install the equipment in a place where it will not be in contact with moisture, water, plants and animals.
- Install the equipment in a location where it will not be damaged by pressure, temperature, humidity, direct sunlight, dust, salts or corrosive products.
- The equipment must be correctly attached according to the service manual and must not be subjected to an inclination greater than 10 °. Risk of tipping.
- This equipment is not designed for use in the presence of vapors from flammable anesthetic mixtures or nitrous oxide.
- Place any other external devices at least 1.5 meters away from the equipment, so that the patient cannot touch any other external devices while they are being attended to.
- The recommendations in this manual for EMC should be followed. Communications equipment and RF generating sources can affect the operation of the equipment.
- Equipment may cause radio interference or interrupt the operation of nearby equipment, making it necessary to take mitigating measures, such as reorientation, relocation of equipment or shielding the location.
- The pedal of this equipment is not suitable for the emergency room.
- System components must meet a protection rating of at least class 1. And be compatible with the components specified by the manufacturer. It does not allow the exchange of the equipment of the electromedical system during its useful life.
- An additional multiple outlet or extension cord cannot be connected to the electromedical system.

Before using the equipment

To help ensure proper hygiene and protect against infectious diseases, before using for the first time, the equipment must be cleaned and disinfected according to the instructions contained in this manual.

While using the equipment

- Under no circumstances can the patient operate the equipment.
- The patient must not touch other parts than those specific to be treated.
- The equipment must be operated only by qualified health professionals.
- To operate the equipment, operating personnel must:
 - Read and understand the user manual
 - Be familiar with the basic structure and functions of this equipment.
 - Be familiar with the emergency situation protocols for this equipment.
 - Be able to recognize irregularities in the operation of the equipment and implement the appropriate

measures, when necessary.

- The equipment has been designed according to the electromagnetic compatibility standards, but in very extreme conditions, it can cause interference with other equipment. Do not use this equipment in conjunction with other devices that are extremely sensitive to interference or with devices that create high electromagnetic disturbances.
- Do not position the patient on the equipment while starting it, as the patient may be injured if the equipment does not work properly. In the event of an error that requires turning the equipment off and on, remove the patient before turning it on again.
- In case of risk to the patient, press the emergency button immediately located on the side of the equipment.
- If this product is exposed to water, moisture or foreign substances, turn it off immediately and contact an Alliage Authorized Service Center.
- In case of damage or defect, do not use the equipment and contact an Authorized Alliage Service Center.
- Do not use the equipment if any of its compartments or parts are damaged, loose or have been removed. Contact an Alliage Authorized Service Center and request repair or replacement of any damaged, loose or removed enclosures or parts of the equipment before using the equipment again.
- Do not touch the equipment or use it if it is being repaired or if the equipment's cabinets have been removed.
- Do not open or remove any of the equipment's cabinets. No internal parts can be repaired by the user.
- In case of falling or impact of moving parts causing it to break, be careful when handling them, there may be sharp parts.
- This equipment does not produce physiological effects that are not obvious to the operator.
- The operator cannot come into contact with the patient when in contact with accessible connectors.
- The operator cannot use tools to open the equipment.

Cross contamination prevention



Adequate cleaning and disinfection measures should be taken to avoid cross-contamination between patients, users and others.

- For each new patient, perform cleaning and disinfection procedures and according to the instructions contained in this manual.

After using / operating the equipment

- Turn off the equipment if it is not in use for a long time
- All parts that have been in contact with the patient must be cleaned and disinfected with each new patient to prevent the transmission of infectious agents that can cause serious illness.
- Perform cleaning and disinfection according to instructions contained in this manual.
- Do not unplug the cable or other connections unnecessarily.
- Do not modify any part of the equipment.

Precautions in case of alteration of the equipment operation

If the equipment shows any abnormality, check if the problem is listed in any item listed in the "Problem diagnosis" topic of this user manual.

If it is not possible to solve the problem, turn off the equipment, contact an Alliage Authorized Technical Assistance.

- The heater can only be replaced by an authorized Alliage service provider.



The manufacturer is NOT responsible:

- If the equipment is used for purposes other than those for which it was designed.
- For damage caused to the equipment, the operator and / or the patient, as a result of incorrect installation and maintenance procedures that do not comply with the operating instructions that accompany the equipment.

Precautions for reducing environmental impact



All environmental indications must be considered by the electromedical system.

Alliage S / A aims to achieve an environmental policy to promote the supply of environmentally conscious medical and dental products that continually minimize environmental impact and are more friendly to the environment and human health.

To maintain a minimal impact on the environment, observe the recommendations below:

- After installation, send recyclable materials for recycling process.
- During the life cycle of the equipment, turn it off when it is not in use.
- To prevent environmental contamination, the disposal of waste and consumables must follow the normal procedure for biomedical waste.

Biomedical waste includes non-acute materials that may cause disease or suspicion of harboring pathogenic organisms that must be stored in a yellow bag properly labeled with a biohazard symbol, stored in a puncture-resistant, watertight container until collection and incineration.



The Equipment's packaging consists of wood, cardboard, plastic and expanded polyurethane (PU) which are 100% recyclable materials.

DIMENSIONS:

Main unit: 1155 X 750 X 855mm /MASSA: Approximately: 163 Kg

Precautions in case of unusable equipment

To avoid environmental contamination or improper use of the equipment, when it is unusable, it must be disposed of (in accordance with current legislation) in an appropriate place, as the materials inside can contaminate the environment.

For the European Economic Area (EEA), this product is subject to Directive 2012/19 / EU, as well as the corresponding national laws. This directive requires that the product must be taken to a special waste collection site at the end of its useful life. Applies to both device and accessories

Contact your dealer if final product placement is required.



This equipment must not be disposed of as household waste.

SYSTEM OVERVIEW

3.SYSTEM OVERVIEW

3.1.SYSTEM DESCRIPTION

The product was conceived in order to maximize the professional dental surgeon's and the patient's experience, by bringing features that bring benefits on a daily basis, such as:

- Lateral lifting system: greater accessibility and ease of practice.
- Seated patient entry: easier for patients with mobility limitations.
- Trendelenburg position: automatic position with the chair movement.
- Large tray: space to accommodate all instruments.

The equipment was constructed using a range of specific materials for each function, namely: steel, cast iron and aluminum in its structure; polyurethane, PVC and leather in its upholstery, steel, plastic and integral-skin in the finishing; plastic or glass in the reflector.

In addition, copper, acrylic, silicone, silicon, tin, among others is used.

3.2.APPLICATION SPECIFICATION

The Dental Chair is designed to support and accommodate the patient to perform dental practices, and the same is for exclusive dental use.

3.2.1.Principles of operation

The Dental Chair is a mechanical system with electric drive of a direct current gear motor with gradual start that allows the movement of the seat elevation and backrest inclination. The Dental Chair is a mechanical system with electric drive of a direct current gear motor with gradual start that allows the movement of the seat elevation and backrest inclination.

3.2.2.Significant physical characteristics

The Dental Chair is built using a range of specific materials for each function, such as steel, cast iron and aluminum in its structure; polyurethane, PVC and leather in its upholstery, steel, plastic and integral-skin in the finish; plastic, glass, etc.

3.2.3.User profile

The Dental Chair can be used by both sexes, with a minimum level of literacy with the ability to read and understand images, symbols, icons, western characters (Arial font), alphanumeric alphabetic characters, and cannot present a degree of visual imperfection for reading or vision and average degree of impairment of recent memory, not being clearly able to perform the activities and functions of the product correctly in the profession.

The user needs to be a qualified and trained health professional to perform the activities, functions frequently used in the application of the Dental Chair and their primary operations functions.

3.3.MAIN PRODUCT COMPONENTS

3.3.1.Chair

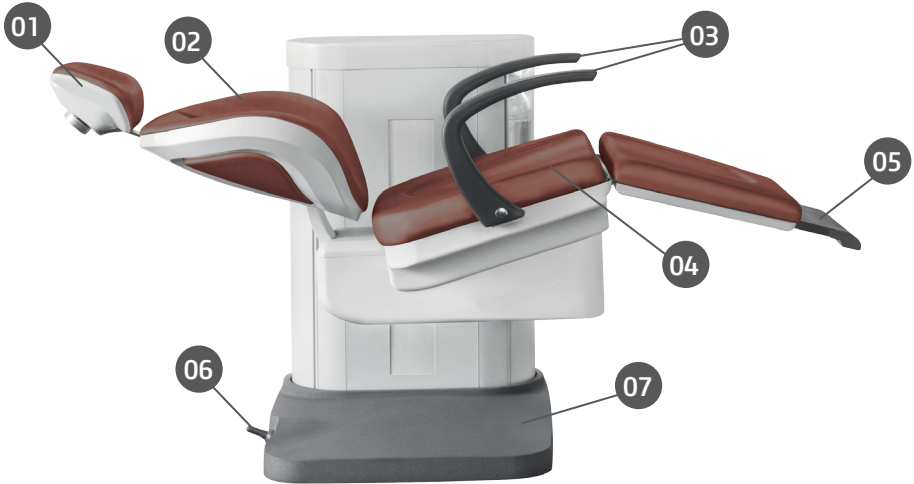

- 01 - Headrest
- 02 - Chest backrest
- 03 - Fixed arms
- 04 - Seat
- 05 - Footrest
- 06 - Joystick
- 07 - Integral Skin Base

3.3.2. Accessories



- *01 - Fixed headrest.
- *02 - Articulating headrest ("click" system).
- *03 - Articulating headrest (operated by handle).
- *04 - Articulating headrest (lever operated).
- *05 - Articulating headrest pneumatic.
- *06 - Fixed arm (2 models).
- *07 - Fixed or retractable arm with side opening (2 models).
- *08 - Fixed / retractable arm (activated by pneumatic system)
- *09 - Pedal with 7 keys (optional mobile or fixed to the base of the chair)
 - 3 working positions;
 - Position returns to zero;
 - Seat down / Seat up / Backrest down / Backrest up;
 - Activation of the reflector..
- *10 - Integrated pedal - Chip Blower
 - 4 working positions;
 - Spitting position;
 - Position returns to zero;
 - Seat down / Seat up / Backrest down / Backrest up;
 - Reversal of the electric micromotor;
 - Activation of the Reflector;
 - Emergency / Blocking of movements;
 - Chip Blower / Water cut;
 - Acceleration rod.
- *11 - Pedal with 11 keys (optional mobile or fixed to the base of the chair)
 - 4 working positions;
 - Spitting position;
 - Position returns to zero;
 - Seat down / Seat up / Backrest down / Backrest up;
 - Activation of the Reflector;
 - Emergency / Blocking of movements.
- *12 - 5-button joystick pedal (optional mobile or fixed to the base of the chair)
 - 3 working positions;
 - Spitting position;
 - Position returns to zero;
 - Seat down / Seat up / Backrest down / Backrest up;
 - Activation of the Reflector;
 - Emergency / Blocking of movements.
- *13 - 3-button Joystick pedal (optional mobile or fixed to the base of the chair)
 - 3 working positions;
 - Position returns to zero;
 - Seat down / Seat up / Backrest down / Backrest up;
 - Activation of the reflector.
- *14 - 7-button joystick pedal
 - 3 working positions;
 - Position returns to zero;
 - Spitting position;
 - Seat down / Seat up / Backrest down / Backrest up;
 - Activation of the reflector.
- *15 - Foot protector.
- *16 - Separate connection box kit.
- *17 - Upholstery fixed by screw.

Owner's Manual

- *18 - Removable upholstery (easy-fix system).
- *19 - Anti-crush device.
- *20 - Side finishing cover
- *21 - Debris filter.
- *22 - Massager Kit
- *23 - Cervical support.
- *24 - Voice AI Kit.

3.4. APPLIED PARTS

The following item is used to accommodate the patient to the equipment.

Type of parts		Contact type	Contact duration	Classification
Upholstery coating	Detachable and Fixed	Skin	35 min	N/A

* Not supplied with the product.

3.5. USER INTERFACE

3.5.1. Integrated pedal control panel - Chip Blower

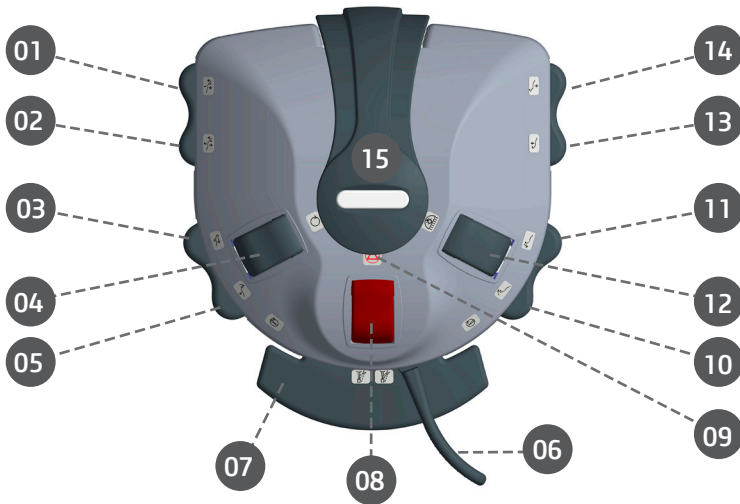

- 01 - Operating Position 1/2
- 02 - Operating Position 3/4
- 03 - Forward tilt
- 04 - Activation of the dental light
- 05 - Automatic reset
- 06 - Electro-pneumatic actuation lever
- 07 - Spray cooling
- 08 - Stop motion

- 09 - Motion stop LED activated
- 10 - It raises the backrest
- 11 - It lowers the backrest
- 12 - Activation of the reflector
- 13 - It raises the seat
- 14 - It lowers the seat
- 15 - Handle for transport (mobile pedal)

Emergency Stop

When pressing the "Emergency Stop" button (08), a LED will light and all chair movements will automatically stop, and will remain blocked until the "Emergency Stop" (08) is pressed again. This operation does not cancel the positions or the programming that has already been recorded. We recommended that this function should be used during long surgical procedures, as the chair will be blocked, therefore not allowing any unexpected movements.

Working Positions

Has four working positions. In order to program them, just place the chair in the position and the dental light at the desired intensity and press and hold for 3 seconds the "working positions 1 and 2" button (01) or "working positions 3 and 4" button (02) at the pedal; the dental chair will sound a beep, and then two beeps in a row, entering cycle, then release the button after the number of beeps regarding the working position you want to program.

To select the first working position, touch once the button (01) of the pedal, for the second, two consecutive touches.

To select the third or fourth position, repeat the same procedure using the button (02).

Button (01):

1 beep = 1st working position

2 beep = 2nd working position

Button (02):

1 beep = 3rd working position

2 beep = 4th working position

Forward tilt "Go back to the last position" and Spitting Position:

When pressing the button "Forward tilt" (03), the light source will turn off (if it was on), water will then flow in the basin (for the duration of the programmed time or if this has not been programmed, for 1 minute), the chair back will raise completely to the Spitting Position, when pressing it again, the back support will return to the previous position and the light source will turn on (if it was on). When pressing the button "Return to zero" (05), the light source will turn off (if it was on), water will then flow in the basin (for the duration of the programmed time or if this has not been programmed, for 1 minutes), the chair back will raise up completely and the chair will go down completely. After activating the "Return to zero" operation (05), or the "Return to the last position", "Spitting Position" (03), or any other operation, this will operate "Stop", and the current position of the chair back will automatically be defined as the "Last position".

Chip-blower system

The chip-blower system allows for the release of the airflow when the turbine is stopped (function of the air). It has a double function key that allows for the operation of the hand set with or without water, as shown below:

A

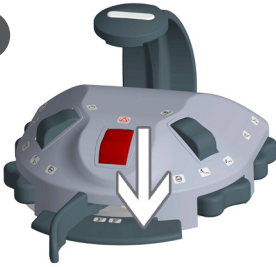

Press key (A) down, will supply air to the tips.

B



Press the key (B) to the right, to supply air to the high RPM micro motor hand sets (only air/ electric).

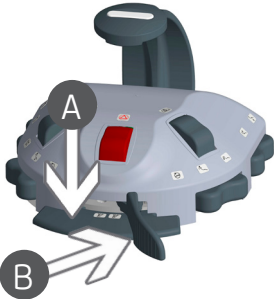

Press the (A) key down, and the lever to the right (B), together, will turn on the high RPM air and water spray turbine.



Put one foot under the transport handle, to move it, lift it sufficiently and place in the desired position.

3.5.2.Three-Key Pedal Control Panel

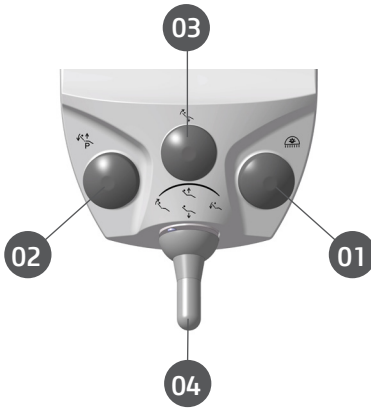

- 01 - Activation of Dental Light
- 02 - Work positions
- 03 - Initial position
- 04 - Joystick
 - Lift backrest
 - Lower backrest
 - Lift seat
 - Lower seat

Seat movement

Press the joystick (04) vertically up/down to lower/lift the seat. To stop the movement, simply stop the joystick.

Backrest movement

Push the joystick (04) sideways to the left/right to lift/lower the backrest. To stop the movement, simply stop the joystick.

Activation of the dental light

Press and release the key (01) to turn the Dental Light on or off.

To change the luminous intensity of the Dental Light, hold down the key until the Dental Light reaches the desired intensity.

Automatic movement to the back to zero position - V0

Press the key (03) so that the seat and backrest simultaneously return to the zero position. This is the most comfortable position for the patient to enter / exit the Dental Chair.

To stop the movement, actuate the pedal in any direction or quickly press the key (03). The reflector will automatically turn off after pressing the button (03).

Working position

Press and release the work position key (02) after:

The first (simple) beep to move the Chair to the working position 1;

The second beep (double) to move the Chair to the working position 2;

The third (triple) beep to move the Chair to the working position 3;

After releasing the key, the seat and the seat backrest will move simultaneously to the chosen working position and the Reflector at the programmed intensity.

To stop the movement, simply press any other command.

Memorization of working positions

These Chairs feature three programmable work positions. The programming is done as follows:

1. Place the Chair in the desired working position using the joystick;
2. Hold down the Job Position key (02). Three beeps will sound and then a long beep, indicating the programming mode. Release the key shortly after:

The first (single) beep is issued for the storage of working position 1;

The emission of the second beep (double) for the storage of working position 2;

The output of the third (triple) beep for storing the working position 3.

It is possible to memorize the intensity of the Reflector together with the working position by setting it to the desired intensity before memorizing.

3.5.3.Five-Key Pedal Control Panel

01 - Emergency Stop

02 - Back to zero

03 - Activation of Dental Light

04 - Forward tilt

05 - Working Positions

06 - Joystick:

- Lift backrest
- Lower backrest
- Lift seat
- Lower seat

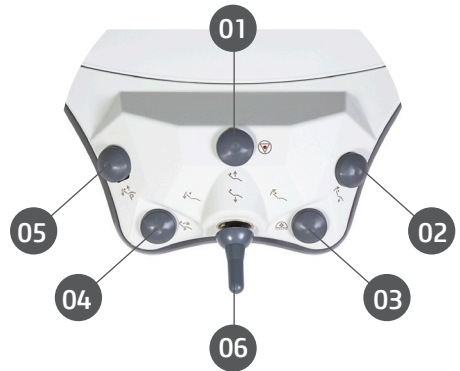

Seat movement

Press the joystick (06) vertically up/down to lower/lift the seat. To stop the movement, simply stop the joystick.

Backrest movement

Push the joystick (06) sideways to the left/right to lift/lower the backrest. To stop the movement, simply stop the joystick.

Activation of the dental light

Press and release the key (03) to turn the Dental Light on or off.

To change the luminous intensity of the Dental Light, hold down the key until the Dental Light reaches the desired intensity.

Automatic movement to the back to zero position - V0

Press the key (02) so that the seat and backrest simultaneously return to the zero position. This is the most comfortable position for the patient to enter / exit the Dental Chair.

To stop the movement, actuate the pedal in any direction or quickly press the key (02). The reflector will automatically turn off after pressing the button (02).

Working position

Press and release the work position key (05) after:

The first (simple) beep to move the Chair to the working position 1;

The second beep (double) to move the Chair to the working position 2;

The third (triple) beep to move the Chair to the working position 3;

After releasing the key, the seat and the seat backrest will move simultaneously to the chosen working position and the Reflector at the programmed intensity.

To stop the movement, simply press any other command.

Memorization of working positions

These Chairs feature three programmable work positions. The programming is done as follows:

1. Place the Chair in the desired working position using the joystick;

2. Hold down the Job Position key (02). Three beeps will sound and then a long beep, indicating the programming mode. Release the key shortly after:

The first (single) beep is issued for the storage of working position 1;

The emission of the second beep (double) for the storage of working position 2;

The output of the third (triple) beep for storing the working position 3.

It is possible to memorize the intensity of the Reflector together with the working position by setting it to the desired intensity before memorizing.

Emergency Stop

When pressing the "Emergency Stop" (01), a LED will light and all chair movements will automatically stop, and will remain blocked until the "Emergency Stop" (01) is pressed again. This operation does not cancel the positions or the programming that has already been recorded. We recommend that this function should be used during long surgical procedures, as the chair will be blocked, therefore not allowing any unexpected movements.

Forward tilt "Spit Position"

When you press the button "Forward tilt" Spit Position "(04), the reflector will turn off (if it is on), it will start the water flow in the basin (until the programmed time or if you have not programmed it for 30 seconds) the backrest will fully rise to the Spit Position, when it is pressed again, the backrest will return to the previous position and the reflector will turn on.

3.5.4. Seven-Key Pedal Control Pane

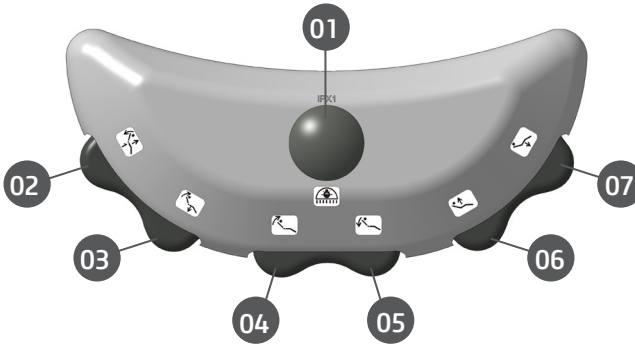

- 01 - Activation of Dental Light
- 02 - Work positions
- 03 - Initial position
- 04 - Lift backrest
- 05 - Lower backrest
- 06 - Lift seat
- 07 - Lower seat

Activation of the dental light

Press and release the key (01) to turn the Dental Light on or off.

To change the luminous intensity of the Dental Light, hold down the key until the Dental Light reaches the desired intensity.

Automatic movement to the back to zero position - V0

Press the key (03) so that the seat and backrest simultaneously return to the zero position. This is the most comfortable position for the patient to enter / exit the Dental Chair.

To stop the movement, actuate the pedal in any direction or quickly press the key (03). The reflector will automatically turn off after pressing the button (03).

Working position

Press and release the work position key (02) after:

The first (simple) beep to move the Chair to the working position 1;

The second beep (double) to move the Chair to the working position 2;

The third (triple) beep to move the Chair to the working position 3;

After releasing the key, the seat and the seat backrest will move simultaneously to the chosen working position and the Reflector at the programmed intensity.

To stop the movement, simply press any other command.

Memorization of working positions

These Chairs feature three programmable work positions. The programming is done as follows:

1. Place the Chair in the desired working position;
2. Hold down the Job Position key (02). Three beeps will sound and then a long beep, indicating the programming mode. Release the key shortly after:

The first (single) beep is issued for the storage of working position 1;

The emission of the second beep (double) for the storage of working position 2;

The output of the third (triple) beep for storing the working position 3.

It is possible to memorize the intensity of the Reflector together with the working position by setting it to the desired intensity before memorizing.

3.5.5. Pedal control panel with seven-key Joystick

- 01 - Back to zero
- 02 - Activation of Dental Light
- 03 - Forward tilt
- 04 - Work positions
- 05 - Joystick:
 - Lift backrest
 - Lower backrest
 - Lift seat
 - Lower seat



Seat movement

Press the joystick (05) vertically up/down to lower/lift the seat. To stop the movement, simply stop the joystick.

Backrest movement

Push the joystick (05) sideways to the left/right to lift/lower the backrest. To stop the movement, simply stop the joystick.

Activation of the dental light

Press and release the key (02) to turn the Dental Light on or off.

To change the luminous intensity of the Dental Light, hold down the key until the Dental Light reaches the desired intensity.

Automatic movement to the back to zero position - V0

Press the key (01) so that the seat and backrest simultaneously return to the zero position. This is the most comfortable position for the patient to enter / exit the Dental Chair.

To stop the movement, actuate the pedal in any direction or quickly press the key (01). The reflector will automatically turn off after pressing the button (01).

Working position

Press and release the work position key (04) after:

The first (simple) beep to move the Chair to the working position 1;

The second beep (double) to move the Chair to the working position 2;

The third (triple) beep to move the Chair to the working position 3;

After releasing the key, the seat and the seat backrest will move simultaneously to the chosen working position and the Reflector at the programmed intensity.

To stop the movement, simply press any other command.

Memorization of working positions

These Chairs feature three programmable work positions. The programming is done as follows:

1. Place the Chair in the desired working position using the joystick;

2. Hold down the Job Position key (04). Three beeps will sound and then a long beep, indicating the programming mode. Release the key shortly after:

The first (single) beep is issued for the storage of working position 1;

The emission of the second beep (double) for the storage of working position 2;

The output of the third (triple) beep for storing the working position 3.

It is possible to memorize the intensity of the Reflector together with the working position by setting it to the desired intensity before memorizing.

Forward tilt "Spit Position"

When you press the button "Forward tilt" Spit Position "(03), the reflector will turn off (if it is on), it will start the water flow in the basin (until the programmed time or if you have not programmed it for 30 seconds) the backrest will fully rise to the Spit Position, when it is pressed again, the backrest will return to the previous position and the reflector will turn on.

3.5.6. Eleven-key pedal control panel

- 17 - Work position 1/2
- 18 - Work position 3/4
- 19 - Forward tilt
- 20 - Initial position
- 21 - Activation of the dental light
- 22 - Emergency stop
- 23 - Activation of the dental light
- 24 - Lift backrest
- 25 - Lower backrest
- 26 - Lift seat
- 27 - Lower seat
- 28 - Emergency Led

Forward tilt

When the key "Forward tilt/ Spitting position" (19) is pressed, the dental light will go off (if it was on), the bowl will drain (for the preset time, and if it was not programmed yet, for four minutes) and the backrest will go up to the spitting position. When pressed again, the backrest will return to the last position and the dental light will go on (if it was on).

Initial position

When pressing the button "Back to zero" (20), the dental light reflector will turn off (if connected), will start the water flow in the basin (until the present time, one minute, or other if you have set it up differently), the backrest will fully rise and the seat will fully descend.

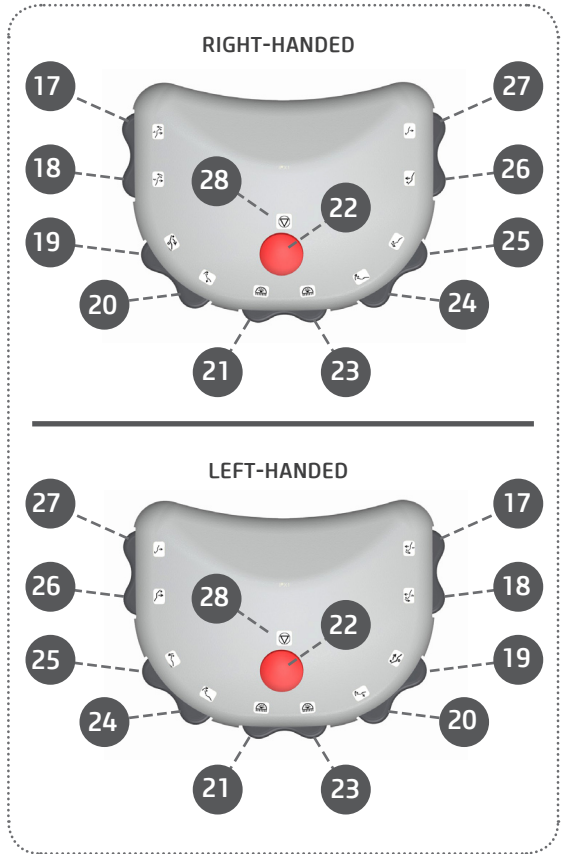

How to turn on the dental light

Press the buttons (21) or (23). Refer to Owner's Manual of Dental light.

Working position

Dental Chair has four working positions. In order to program them, just place the chair in the position and the dental light at the desired intensity and press and hold for 3 seconds the "working positions 1 and 2" button (17) or "working positions 3 and 4" button (18) at the pedal; the dental chair will sound a beep, and then two beeps in a row, entering cycle, then release the button after the number of beeps regarding the working position you want to program.

To select the first working position, touch once the button (17) of the pedal, for the second, two consecutive touches.

To select the third or fourth position, repeat the same procedure using the button (18).

Button (17):

- 1 beep = 1st working position
- 2 beep = 2nd working position

Button (18):

- 1 beep = 3rd working position
- 2 beep = 4th working position

ATTENTION:

When the "Emergency stop" (22) key is pressed, the LED (28) will be on and all chair movements are interrupted until pressed again. This operation does not erase previously recorded positions and programming. We recommend its use during long surgical procedures, because all chair movements are blocked, thus preventing unexpected movements.

After pressing the "Initial position" (20) key or the "Last position/Spitting position" (19) key, any other operation will trigger the "Stop", and automatically the backrest current position will be defined as "Last position".

3.5.7. Massager control

- 01 - Numerical display of the percentage of speed and intensity (0 to 99%).
- 02 - Speed or intensity control.
- 03 - 1 Speed
2 Intensity
First digit indicates whether the selected command is to change the speed (1) or the intensity (2).
- 04 - Programming: Wave / Continuous / Pulse.
After selecting the desired option, the Led indicates the option it is in.
Note: When the wave option is activated, the two zones (Z1 and Z2) are automatically activated.
- 05 - Zone (1)
Zone (2)
Selection of the area to be massaged.
Back or legs, being able to select the two zones together. The Led indicates the option you are in.
If both zones are selected, the two LEDs will be on.
- 06 - On / Off and running time.
The Led indicates the option you are in.
The 1st. short click turns the massager on in 10 minutes
The 2nd. short click changes to 20 minutes.
The 3rd. short click returns to the 10th minute time.
Long click turns off the massager.

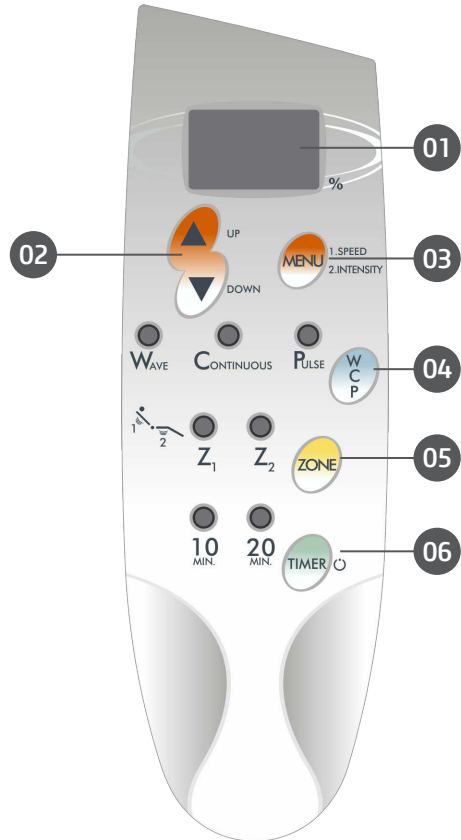

3.5.8. Emergency stop button





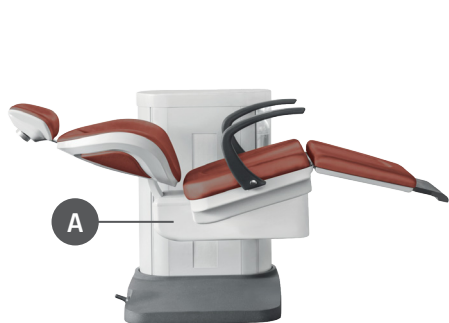

The equipment has an emergency stop button which, when activated, interrupts all operation of the equipment related to movement.

After pressing the emergency button, it will remain locked until the operator is released.

3.6. LABEL POSITIONING

The following figure illustrates the location of the labels on the equipment components.



 Alliage S/A Indústrias Médico Odontológica Rod. Abrão Assed, Km 53 + 450m - CEP 14097-500 Ribeirão Preto - SP - Brazil - Tel.: +55 (16) 3512-1212		
PRODUCT / PRODUTO		POWER INPUT / POTENCIA DE ENTRADA
DENTAL CHAIR / CADEIRAS ODONTOLÓGICAS		127 / 220 V~ 50/60 Hz 350 VA
MODEL		OPERATION OPERAÇÃO
SN	O.P	T.on: 1min / T.off: 4min
		Registro ANVISA:
EC REP		  
CENTERQUAL - Soluções de Comércio Internacional, Lda. Avenida Defensores de Chaves, Nº4 Escritório (3a Spaces) 1000-117 Lisboa, Portugal		



* ILLUSTRATIVE PICTURE

3.7.SYSTEM REQUIREMENTS

3.7.1.Compressor requirements

The compressor is required to provide compressed air for clinical and laboratory use, having stable performance and flow capacity in accordance with the minimum requirements required for the installation of the dental office, in addition to being oil-free or emitting fumes, vapors or odors unpleasant.

It must have a safety system with a valve that goes into operation to release the pressure in case the pressure switch fails and also an overload protector in order to protect the equipment from overheating. The location of your installation should be an airy place, preferably outside the office and should not be installed in sanitary facilities such as bathrooms and toilets, in order to minimize the contamination of the air used in the offices.

For the safety of the patient, the operator and the perfect functioning of the product, the installation of the compressor must respect the following recommendations:

Install a pressure relief device next to the compressor;

Install an air filter with pressure regulator, thus preventing oil, moisture and solid particles from entering the office and subsequently reaching its vital parts, such as; valves, hand parts, etc.;

Install the compressor close to the supply point to avoid losses;

In installations, preferably use rigid copper tubes. The pipes can also be made with galvanized steel, stainless steel, nylon or polyethylene tubes.

Pressure limit of 80 psi;

Flow rate limit ≥ 47 NL / min;

Humidity limit between 40 and 60%;

Oil contamination limit of 0.5 mg / m³;

Particle contamination limit <100 particles / m³ (particles between 1 and 5 μ m in size);

Air quality regulations are in accordance with the laws of each country.

3.7.2.Vacuum pump requirements

The Vacuum Pump is required to have high suction power, in order to allow the professional a better visualization of the operative field with reduced risk of contamination by aerosol and greater comfort to the patient, avoiding his constant displacement to the water unit, during the clinical procedure. The proper functioning of the Vacuum Pump is essential to ensure infection control in the office and asepsis of the patient's oral cavity, as it aspirates and drains residuals from the oral environment out of the office. The larger parts of the solids must be retained in a debris separator, from where they must be removed daily.

The Vacuum Pump must be installed in a location where it will not be damaged by pressure, temperature, humidity, direct sunlight, dust or salts. The equipment must not be subjected to inclination, excessive vibrations, or shocks (including during transport and handling).

The suction power must be regulated by a register according to the needs of the office and the motor must have a thermal protector, which turns the equipment off in case of overheating and prevents the motor from burning.

The Vacuum Pump must have a minimum vacuum pressure of 75 mmHg so that suckers have sufficient suction power for the suction of the oral cavity and the value for maximum vacuum pressure must be 500 mmHg per installed office.

In order to considerably increase the service life of its components, the materials used in manufacturing must be highly resistant to corrosion.

For the safety of the patient, the operator and the perfect functioning of the product, the installation of the Vacuum Pump must respect the following recommendations:

The equipment was not designed for use in environments where vapors, flammable anesthetic mixtures with air, or oxygen and nitrous oxide can be detected;

The equipment must be properly grounded;

Although this equipment has been designed in accordance with electromagnetic compatibility

standards, it can, in very extreme conditions, cause interference with other equipment. Do not use this equipment in conjunction with other devices that are extremely sensitive to interference or with devices that create high electromagnetic disturbances;

Do not subject the plastic parts to contact with chemical substances used in dental treatment routines. Such as: acids, mercury, acrylic liquids, amalgams, etc. .;

Avoid spilling water or other liquids inside the equipment, which could cause short circuits;

Before starting the operation of the Vacuum Pump, make sure that the plug of the voltage input cable is connected to the mains, and that the water supply valve is open;

The lack of water will cause damage to the mechanical seal and the Vacuum Pump will not aspirate; Never use detergent or any foaming product to clean the suction tubes of the Vacuum Pump internally;

Do not modify any part of the equipment. Do not unplug the cable or other connections unnecessarily; Before cleaning the equipment, turn off the main switch;

Do not use microabrasive material or steel wool for cleaning, do not use organic solvents or detergents that contain solvents such as ether, stain remover, etc.;

To avoid risk of infection, wear protective gloves when handling filters and drains. Dispose contaminated waste and products in biological waste;

Never use foaming products for suction (Descalers, Detergents, Floats, etc.), this procedure may damage the internal parts of the Vacuum Pump motor;

Never use the bleach solution for external cleaning of the Vacuum Pump and / or any equipment, as this mixture is highly corrosive and can damage metal parts;

3.7.3. Installation location

The environment for which the Dental Chair is intended, must follow the safe environment requirements for the user, patient and third parties that meet the parameters of the ambient temperature range, relative humidity range, operating altitude, electromagnetic compatibility and clean environments.

The product is intended for use in the healthcare field only.



To meet safety standards, do not operate non-medical equipment, such as personal computers, within the patient's area. Outside the patient's area, the presence of non-medical equipment is acceptable, provided that approved and certified computer equipment is used.

Computer equipment must be CE approved and must comply with CE 60950-1: 2005 + AMD1: 2009 + AMD2: 2013 and EMC 2014/35 / EU and 2014/30 / EU low voltage guidelines.

3.8.SYSTEM ARRANGEMENT



* Do not accompany the product

4

OPERATION

4. OPERATION

4.1. INITIAL PREPARATION



The equipment must be cleaned and disinfected before use on a new patient, observing the instructions contained in this manual.



To isolate the equipment from the mains, use the general switch.

Main switch

Turn on the main switch located on the back of the product.

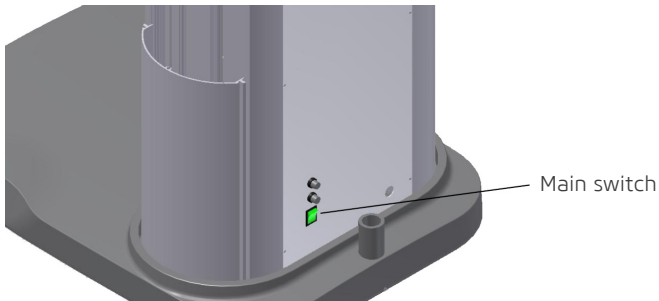

Seat Movement

Activate the joystick vertically up/ down to lower/ raise the seat. To stop the movement, just stop activating the joystick.

Backrest Movement

Activate the joystick laterally to the left/ right to raise/ lower the backrest. To stop the movement, just stop activating the joystick.

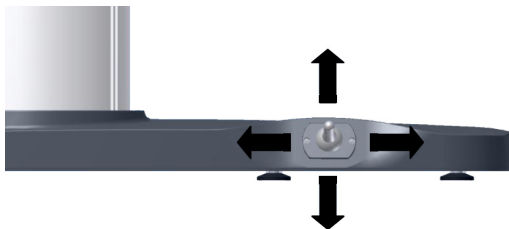

Headrest

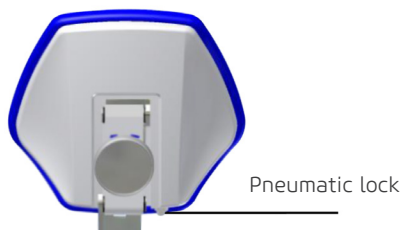

Press and hold the pneumatic lock to release the set brake. Position the backrest in the desired position, when reaching the desired position, release the lock to lock the set.

4.2.MASSAGER CONTROL FUNCTIONS

To turn the massager on, press the on / off key and to turn it off keep it pressed for 1 second. With the massager already on, press the timer key to choose how long it will remain on, 10 or 20 minutes, after this time the massager will turn off automatically. Check which time is selected by the LEDs. After switching off the massager can be switched on again.

Use the WCP key to choose between Wave, Continuous or Pulse modes. The selected mode can be checked on the corresponding LEDs.

The operator can choose to keep only the backrest massager on or just the seat massager or both (except in Wave mode where the two remain connected), for this use the ZONE key to choose between "Zone 1" (backrest) and / or "Zone 2" (seat), the selection can be checked on the corresponding LEDs. The speed and intensity of the massager can be adjusted using the MENU key that selects what will be edited and the UP and DOWN key that promotes the adjustment of the values from 0% to 99%, the percentages are shown on the right side of the display in green. When pressing the MENU key, numbers 1 and 2 will alternate on the left side of the display. Number 1: speed adjustment and number 2: intensity adjustment.

4.2.1.Wave mode

In this mode the massagers increase and decrease their intensity over time, alternating between the back massager and the seat massager, that is, when one of them is more intense the other is at its lowest intensity. The speed and the highest level of intensity can be adjusted. In this mode the massagers work together, and it is not possible to activate just one of them.

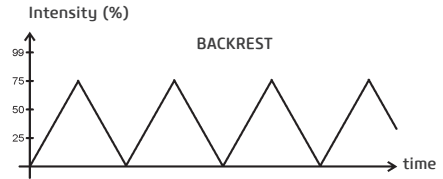
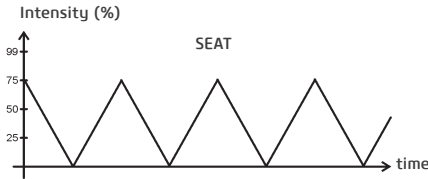

4.2.2.Continuous mode

In this mode the massagers operate continuously. The intensity can be adjusted. Seat and back can be operated individually.

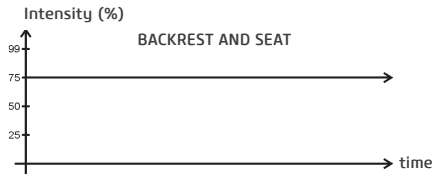

4.2.3.Pulse mode

In this mode, massagers pulse in a synchronized manner. The intensity and speed can be adjusted. Seat and back can be operated individually.

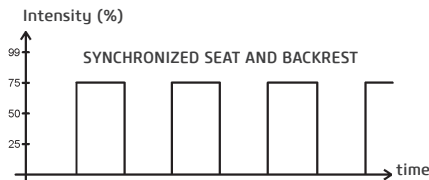

4.3. VOICE MODULE

4.3.1. Virtual Assistant Setup



The virtual assistant must be compatible with the voice module and the speaker device.

1) Turn on the Dental Chair.

2) With the speaker device already configured on wi-fi and close to the Chair (within a radius of 3 meters), go to the wi-fi settings of your mobile device or computer.

3) Connect your mobile device (or computer) to the network called "Alliage", if you prefer, use the QR Code below.



4) If you are using a mobile device, scan the QR Code below to enter configuration mode.



If you use a computer, enter the browser, and access the link: <http://192.168.4.1>, you will be redirected to the configuration page, as shown in the image below.



5) With the Alliage's configuration page open, click on "setup wi-fi".

6) A page will appear with all available nearby Wi-Fi networks, select the one your device is connected to, enter the password, and click "save".



7) After a few seconds, the setup screen will automatically close, and your mobile device/ computer will revert to its default Wi-Fi network and your chair will also be connected.

8) Open your Virtual Assistant app where your device is already configured.

9) In the bottom menu, click on "devices".

10) In the upper right corner, click the "+" icon.

11) Click on add device, scroll to the bottom of the page, and click on the option "others", your device will start the search for the chair (remember to keep your device close to the Chair) to confirm that the device has started the search, a led will light up in blue color around the device.

12) Wait about 45 seconds until you find the Chair devices, once you find it, close the window and your Chair will be ready to receive the Virtual Assistant commands.



If the speaker device does not find the Chair devices, turn off the Chair, wait 5 seconds, turn it on again and repeat steps 8 to 12.

4.3.2. Using the Virtual Assistant

With the Virtual Assistant, you can control the Dental Chair using voice command. Below are the commands available on the Chair. To activate the commands, an activation word is needed to call the assistant [NAME] and then request the command.

Adjusting the brightness of the reflector:

To trigger this function, just say:

[NAME],

- Turn on reflector
- Turn on reflector at 50% (The percentage can be from 0 to 100%)
- Turn off reflector



Say the percentage understandably. If your assistant doesn't recognize the % the reflector will go to 100%.



Reflector models with intensity adjustment by proximity sensor, does not allow percentage adjustment.



Move the chair:

Preset positions:

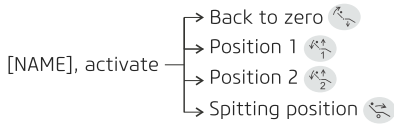

Desired positions: If you want to move your chair to non-preset positions, your assistant accepts the following commands:

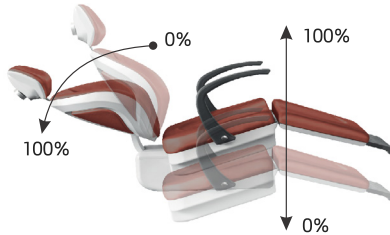
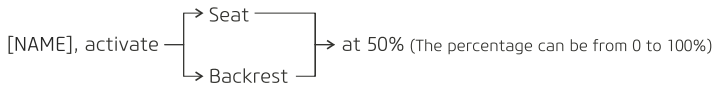

Say the percentage understandably. If your assistant does not recognize the %, the seat or backrest will go to 100%.

Water unit:

To trigger this function, just say:

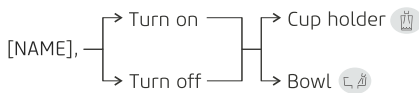

The virtual assistant is quite versatile and accepts several alternative commands for the same functions. For example: trigger, activate and turn on can be used as alternatives.

5

CLEANING, DISINFECTION AND STERILIZATION

5. CLEANING AND DISINFECTION



Before starting the cleaning and disinfection procedure, turn off the main switch of the equipment to avoid permanent damage.



For your protection, during the cleaning and disinfection process of the equipment use PPE such as disposable gloves and goggles.



The cleaning and disinfection of each component of the electromedical system is described in the manuals for each component.

The cleaning and disinfection process must be performed at each patient change.

When starting the process, check for visible dirt, such as blood or saliva.

Carefully clean the patient's entire contact area, such as upholstery lining.

For cleaning use a clean, soft cloth moistened with mild soap and then dry with a clean, soft cloth or paper towel.

For the disinfection process of the equipment, use a disinfectant detergent foam that has active components based on didecyldimethylammonium chloride.

Apply the disinfectant detergent foam on the surface or on a clean cloth and spread it on the surface to be treated. Respect the antimicrobial contact time specified by the manufacturer.

After application, allow to dry. Do not rinse.

There is no limit on cycles or application time that the equipment and its parts can tolerate during the cleaning and disinfection process, following the instructions in this manual.



Do not spill liquid disinfectant on the equipment.



Do not use organic solvents, for example, thinner, to clean the equipment.

In the event that the developer solution is spilled on the panel, clean it immediately, as these solutions may compromise the equipment's paint.



Sterilization parameters must always be followed.

Accessories that are not properly sterilized can cause disease in patients.

6

TROUBLESHOOTING

6.TROUBLESHOOTING

6.1.PROBLEMS SOLUTION

In case you encounter any problem in the operation, follow the instructions below to check and fix the problem, and / or contact your representative.

UNFORESEEN	PROBABLE CAUSE	SOLUTIONS
- Chair totally inoperative.	- Anti-crushing device activated. - Emergency button activated. - Power outages on the network. - Main switch off. - Fuse(s) blown.	- Release anti-crush device - Press the “Emergency stop” button again. - Connect the plug to the outlet. - Wait for normalization of the network. - Turn on general key. - Turn off the chair power and request the presence of a Technician.
- Massager totally inoperative.	- Massager activation button on the equipment panel not activated. - Poor contact of the massager power cable. - Fuse(s) blown.	- Press the massager activation button. - Check the connections. - Turn off the power to the chair and request the presence of a Technician.
- It takes time to save network credentials during wi-fi network setup.	- An unstable or slow internet makes it difficult to communicate with the virtual assistant devices.	- Restart the local wi-fi network.
- It is not possible to communicate with the "Alliage" network to register the wi-fi network.	- An unstable or slow internet makes it difficult to communicate with the virtual assistant devices.	- Try disconnecting from the "Alliage" network and connect again. Also try using the QR codes provided in the installation guide to access the configuration page when connected to the "Alliage" network.
- The virtual assistant activates the reflector in wrong intensity (percentage).	- The virtual assistant uses the last used intensity value if not specified in the command.	- Always specify the intensity of the reflector when activating it by the virtual assistant.
- The virtual assistant always activates the spotlight at maximum intensity.	- If the virtual assistant does not understand the requested intensity, it will use the maximum value.	- Try to speak clearly as a virtual assistant.
- Virtual assistant says devices are not responding after commands.	- An unstable or slow internet makes it difficult to communicate with the virtual assistant devices.	- Restart the local wi-fi network.

<ul style="list-style-type: none">- The virtual assistant did not discover all new chair devices during the scan.	<ul style="list-style-type: none">- An unstable or slow internet makes it difficult to communicate with the virtual assistant devices.	<ul style="list-style-type: none">- Try restarting your internet and starting the search again.
<ul style="list-style-type: none">- The virtual assistant does not detect any chair device during the scan.	<ul style="list-style-type: none">- During the chair's wi-fi configuration, you must choose the same network that the virtual assistant is connected to.	<ul style="list-style-type: none">- Reset the chair as instructed in the guide and reconfigure using the same network as the virtual assistant.
<ul style="list-style-type: none">- After changing the language of the virtual assistant devices, it is no longer able to detect them.	<ul style="list-style-type: none">- It is necessary to remove the old devices of the previous language of the virtual assistant so that it is possible to detect the new devices.	<ul style="list-style-type: none">- Remove all devices from the virtual assistant chair through the app or voice commands and then search.
<ul style="list-style-type: none">- The chair does not respond to the virtual assistant after switching the devices' language.	<ul style="list-style-type: none">- It is necessary to remove the old devices of the previous language of the virtual assistant to be able to detect the new devices.	<ul style="list-style-type: none">- Remove the new devices from the chair via the app or by voice command and then search for them again.
<ul style="list-style-type: none">- The chair does not respond to the virtual assistant after changing the wi-fi password.	<ul style="list-style-type: none">- It is necessary to reset the module and configure it again as instructed in the manual in case of changing the password of the wi-fi network.	<ul style="list-style-type: none">- Follow the module's instructions to reset the device and reconfigure the Wi-Fi network.

If the problem persists, contact the Alliage Service Department.

7

INSPECTION AND MAINTENANCE

7. INSPECTION AND MAINTENANCE



Maintenance or service procedures may only be carried out by a technical service authorized by the manufacturer.

The components of the electromedical system do not have additional measures during preventive maintenance.

All instructions for using the equipment as intended are provided in this user guide. If a problem is detected and cannot be corrected with the instructions in the problem diagnostics section, contact the Alliage Service Department.

7.1. PERIODIC INSPECTION

It is imperative that this equipment be regularly inspected to ensure operational safety and functional reliability. This inspection must be carried out by personnel familiar with the necessary precautions to avoid exposing the patient to risk.

Periodic inspection should be carried out at regular intervals (at least once a year) to ensure that the product is permanently safe and operational. All components subject to normal wear and tear should be checked and, if necessary, replaced.

The manufacturer and the assembler / installer are exempt from responsibility for the standard results not being compliant in cases where the user does not perform the maintenance recommended by the manufacturer.

Neither inspection nor service is part of the equipment warranty.

Maintenance performed must be documented and maintained with the equipment.

The table below gives a description of the main inspection items and recommended frequency.

ITEM	INSPECTION DESCRIPTION	RECOMMENDED FREQUENCY*
Security system	Collision, Warning lights and Interlock	Diary
Electrical parts	Overheating / Noise / Burning smell	Monthly
Elevation	Operation / Noise / Vibration	Yearly
Drive mechanism	Operation / Noise / Vibration	Yearly
Pedal and Controls	Operation / Damage	Yearly

If problems are detected during the inspection, contact the Alliage Service Department.

7.2. PREVENTIVE MAINTENANCE

In addition to the annual inspection, to ensure a long service life and smooth operation of your equipment, it is important to carry out preventive maintenance for a maximum period of three (3) years.

Contact the Alliage Service Department about our periodic review and preventive maintenance program.

7.3.CORRECTIVE MAINTENANCE



To repair or replace any part or part see instructions in the service manual.



Corrective maintenance cannot be performed by the user.

Do not open the equipment or try to repair it yourself or with the help of someone without training or authorization. This can aggravate the problem or produce a failure that can compromise the safety of the equipment.



The power cables, electronic boards, fuses and belts can be changed only by the authorized technician. See service manual for connection and anchoring information.



The equipment or any of its parts cannot be maintained or serviced during use with a patient.



The equipment contains parts under high voltage. Risk of electric shock. Turn off the main switch before servicing.



Moving parts can cut or crush.



This equipment cannot be tilted more than 10 °. Risk of tipping.



The service manual is only available for Authorized Technical Assistance.

Alliage declares that the provision of circuit diagrams, component lists or any other information that provides technical assistance on behalf of the user, can be requested as long as previously agreed between the user and Alliage.

The warranty will be void if the original parts are removed / replaced by unauthorized service technicians.

7.4.ALLIAGE AUTHORIZED SERVICE NETWORK

All services performed on the Alliage equipment must be performed by an Authorized Technical Assistant, as otherwise they will not be covered by the warranty.

If you need to order electrical schematics and or component specification that is not stated in the user manual, use the Alliage Customer Service to make the request.

Telephone: +55 (16) 3512-1212

Address: Rodovia Abrão Assed, Km 53 - Recreio Anhanguera – Ribeirão Preto -SP/ Brazil ZIP CODE 14097-500

8

WARRANTY

8.WARRANTY

This equipment is covered by the warranty periods, terms and conditions contained in the Warranty Certificate that comes with the product.

9

STANDARDS AND REGULATIONS

9. STANDARDS AND REGULATIONS

This equipment has been designed and manufactured to meet the following rules:

ABNT NBR IEC 60601-1:2010 Amendment 1:2016	Medical Electrical Equipment - Part 1: General requirements for basic security and essential performance.
ABNT NBR IEC 60601-1-2:2017	Medical Electrical Equipment, Part 1-2: General basic safety requirements and essential performance - Collateral standard: Electromagnetic interference - Requirements and tests.
ABNT NBR IEC 80601-1-60:2015	General requirements for basic safety and essential performance of dental equipment.
ABNT NBR 60601-1-6:2011	Electromedical equipment - Part 1-6: General requirements for basic safety and essential performance - Collateral standard: Usability.
ABNT NBR IEC 62366:2016	Health products - Application of usability engineering to health products.
IEC 60601-1-9:2014	Medical electrical equipment - Part 1-9: General requirements for basic safety and essential performance - Collateral standard: Requirements for environmentally conscious design.
IEC 62304:2006	Medical device software - Software lifecycle processes.
ISO 9680:2014	Operating lights.
ISO 7494-1:2011	Dentistry – Dental units – Part 1: General requirements and test methods.
ISO 7494-2:2015	Dental units – Part 2: Air, water, suction and wastewater systems.
ABNT NBR ISO 6875:2014	Dental patient chair.
ISO 9687:2015	Graphical symbols for dental equipment.
ISO 15223-1:2016	Graphic symbols for electrical equipment in medical practice.
EN 1041:2008+A1 2013	Information provided by the medical device manufacturer.
ABNT NBR ISO 10993-1:2013	Biological assessment of medical devices - Part 1: Assessment and testing.
ABNT NBR ISO 14971:2009	Medical devices - Application of risk management to medical devices.
ABNT NBR ISO 13485:2016	Quality management systems - Requirements for regulatory purposes.

10

TECHNICAL SPECIFICATIONS

10. TECHNICAL SPECIFICATIONS

10.1. EQUIPMENT CLASSIFICATION

EQUIPMENT CLASSIFICATION

Class of classification according to ANVISA	Class I
---	---------

Class of classification according to CE / FDA	Class I
---	---------

CLASSIFICATION OF EQUIPMENT ACCORDING TO STANDARD EN IEC 60601-1

Product classification for applied parts	Type B
--	--------

Protection Against Electric Shock	Class I
-----------------------------------	---------

Protection Against Harmful Water Penetration	IP00 - Chair - Product not protected against harmful penetration of water and particulate material IP01 - Pedal - Product not protected against penetration of particulate material and protected against vertical drops of water droplets (condensation)
--	--

Degree of safety of application in the presence of a flammable anesthetic mixture with air, oxygen or nitrous oxide	Unsuitable equipment
---	----------------------

Operation mode	Non-continuous operation Operating time: Ton: 1 min. / Toff: 4 min.
----------------	---

10.2.APPLIANCE INFORMATION

GENERAL INFORMATION	
Power supply voltage	127/220 V~
Power supply frequency	50 / 60 Hz
Allowable fluctuation	+/- 10 %
Number of phases	Biphasic
Masker key	Single pole More than 100000 cycles 20A / 250 VAC
Input Fuses	T10A H 250 V (127V~) - T8A H 250 V (220V~)
Maximum grid impedance	0,2Ω
Maximum load	200 kg
Maximum pressure:	80 psi
Flow rate:	≥ 47 NL/min
Humidity limit	40 a 60%
Oil contamination limit	0,5 mg/m ³
Particle contamination limit	<100 particles / m ³ (particles between 1 and 5µm in size)
Power consumption	530 VA
Chair net weight	130 kg
Gross chair weight	163 kg

10.3.ENVIRONMENTAL CONDITIONS

ENVIRONMENTAL CONDITIONS OF TRANSPORT AND STORAGE	
Transport or storage ambient temperature range	-12°C to +50°C
Transport and storage relative humidity range	< 85% RH
Atmospheric pressure range	700 hPa to 1060 hPa (525 mmHg to 795 mmHg)

ENVIRONMENTAL CONDITIONS OF INSTALLATION AND OPERATION	
Ambient operating temperature range	+10°C a +35°C
Operating relative humidity range (non-condensing)	< 75% RH
Atmospheric pressure range	700 hPa to 1060 hPa (525 mmHg to 795 mmHg)
Operating altitude	≤ 2000 m

10.4.CHAIR DIMENSIONS

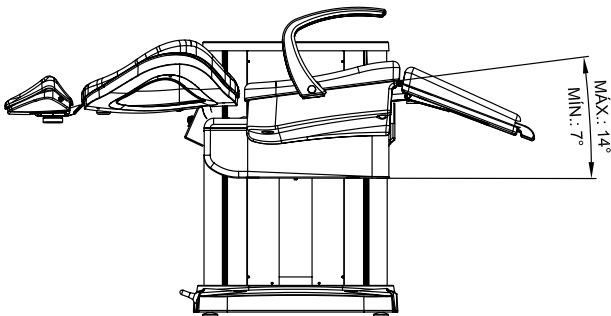
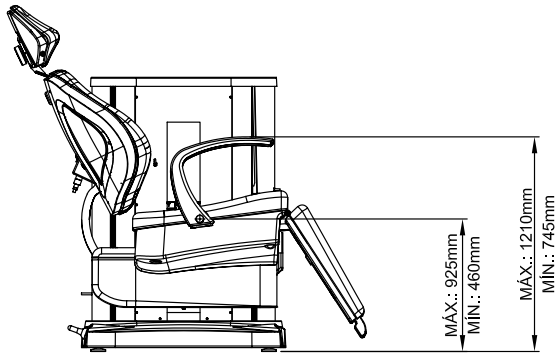
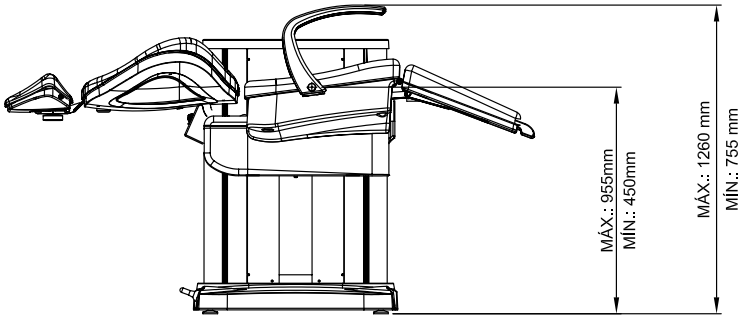

Merely illustrative images. The dimensions of the Dental Chair can vary in height and length by up to $\pm 7\%$.

ELECTROMAGNETIC COMPATIBILITY

11.ELECTROMAGNETIC COMPATIBILITY

Dental Chairs are intended for use in the electromagnetic environment specified below. The buyer or user should ensure that it is used in such an environment.

Dental Chairs are suitable for use in a professional healthcare environment, not including areas where there is sensitive equipment or sources of intense electromagnetic disturbances, such as the RF shielded room of a system for magnetic resonance imaging, in operating rooms close to active AF surgical equipment, electrophysiology laboratories, armored rooms or areas where short wave therapy equipment is used.

The following tables provide information on the equipment's compliance with the ABNT NBR IEC 60601-1-2: 2017 Standard.

11.1.GUIDANCE AND DECLARATION FOR ELECTROMAGNETIC EMISSIONS

EMISSIONS TESTS	COMPLIANCE	ELECTROMAGNETIC ENVIRONMENTS - GUIDELINES
RF emissions CISPR 11	Group 1	Dental Chairs use RF energy only for their internal functions. Therefore, its RF emissions are extremely low and are unlikely to cause any interference in nearby electronic equipment.
RF emissions CISPR 11	Class A	Dental Chairs are suitable for use in all establishments, except domestic ones and those directly connected to the public low voltage power supply network that powers buildings used for domestic purposes.
Harmonic emissions IEC 61000-3-2	Class A	
Voltage fluctuation / Scintillation emissions IEC 61000-3-3	Compliant	
Note: The emission characteristics of this equipment make it suitable for use in industrial areas and hospitals (IEC / CISPR 11, Class A). If used in a residential environment (for which IEC / CISPR 11, Class B is normally required), this equipment may not provide adequate protection for radio frequency communication services. The user may need to take mitigation measures, such as relocating or redirecting equipment.		

11.2. ORIENTATION AND DECLARATION FOR ELECTROMAGNETIC IMMUNITY

PHENOMENON	BASIC EMC STANDARD OR TEST METHOD	IMMUNITY TEST LEVEL	COMPLIANCE LEVEL
Electrostatic discharge	IEC 61000-4-2	± 8 KV contact ± 2 KV, ± 4 KV, ± 8 KV, ± 15 KV air	± 8 KV contact ± 2 KV, ± 4 KV, ± 8 KV, ± 15 KV air
EM fields of radiated RF	IEC 61000-4-3	3 V / m 80 MHz - 2.7 GHz 80% AM at 1 kHz	3 V / m 80 MHz - 2.7 GHz 80% AM at 1 kHz
Fields in the vicinity from RF wireless communications equipment	IEC 61000-4-3	See table	See table
Fast / saved electrical transients	IEC 61000-4-4 alternating current power input	± 2 kV 100 kHz repetition frequency	± 2 kV 100 kHz repetition frequency
	IEC 61000-4-4 signal input / output	± 1 kV 100 kHz repetition frequency	± 1 kV 100 kHz repetition frequency
Outbreak Line by line	IEC 61000-4-5	± 0,5 kV, ± 1 kV	± 0,5 kV, ± 1 kV
Outbreak Ground line	IEC 61000-4-5	± 0,5 kV, ± 1 kV, ± 2 kV	± 0,5 kV, ± 1 kV, ± 2 kV
Conducted disorders induced by RF fields	IEC 61000-4-6	3 V 0.15 MHz - 80 MHz 6V in ISM bands between 0.15 MHz and 80 MHz 80% AM at 1 kHz	3 V 0.15 MHz - 80 MHz 6V in ISM bands between 0.15 MHz and 80 MHz 80% AM at 1 kHz
Magnetic fields at the stated feed frequency	IEC 61000-4-8	30 A/m 50 Hz or 60 Hz	30 A/m 50 Hz or 60 Hz
Voltage drops	IEC 61000-4-11	0 % UT; 0,5 cycle A 0°, 45°, 90°, 135°, 180°, 225°, 270° and 315° 0 % UT; 1 cycle e 70 % UT; 25/30 cycle Single phase: a 0°	0 % UT; 0,5 cycle A 0°, 45°, 90°, 135°, 180°, 225°, 270° and 315° 0 % UT; 1 cycle e 70 % UT; 25/30 cycle Single phase: a 0°
Voltage interruptions	IEC 61000-4-11	0 % UT; 250/300 cycles	The device will shut down and / or reset if the power is interrupted for five seconds.

NOTE 1 At 80 MHz and 800MHz, the higher frequency range is applicable.
 NOTE 2 These guidelines may not apply in all situations. Electromagnetic propagation is affected by absorption and reflection from structures, objects and people.
 NOTE 3 UT is the AC mains voltage before applying the test level.

PROXIMITY FIELDS FROM WIRELESS RF COMMUNICATIONS EQUIPMENT

TEST FREQUENCY (MHZ)	BAND (MHZ)	SERVICE	MODULATION	MAXIMUM POWER (W)	DISTANCE (M)	IMMUNITY TEST LEVEL (V/M)
385	380-390	TETRA 400	18Hz pulse modulation	1.8	0.3	27
450	430-470	GMRS 460,FRS 460	FM deviation of ± 5 kHz 1kHz sinusoidal	2	0.3	28
710	704-787	Band LTE 13, 17	217 Hz pulse modulation	0.2	0.3	9
745						
7480						
810	800-960	GSM 800/900, TETRA 800, iDEN 820, CDMA 850, Band LTE 5	18Hz pulse modulation	2	0.3	28
870						
930						
1720	1700 -1990	GSM 1800; CDMA 1900; GSM 1900; DECT; Band LTE 1, 3, 4, 25; UMTS	217 Hz pulse modulation	2	0.3	28
1845						
1970						
2450	2400-2570	Bluetooth, WLAN 802.11 b/g/n, RFID 2450, Band LTE 7	217 Hz pulse modulation	2	0.3	28
5240	5100 - 5800	WLAN 802.11 a/n	217 Hz pulse modulation	0.2	0.3	9
5500						
5785						

LIST OF USED CABLES

CABLES	DESCRIPTION	LENGTH
Power	Tripolar Power Cable 3x Gauge 2.50 mm ² , 250V AC, Male Plug 20A NBR 14136 2P + T, without female plug, INMETRO.	3 m



Dental Chairs are intended to assist health professionals, and they are for exclusive dental use. In the event of EMC disturbances, the operator may experience loss of communication between the equipment and controls.



Compliance with EMC and EMI standards cannot be guaranteed by using cables that have been altered or that do not comply with the same standards as the equipment has been validated.



Use of this equipment adjacent to other equipment should be avoided as it may result in improper operation. If this use is necessary, it is advisable that this and the other equipment be observed to verify that they are operating normally.



Do not use accessories, transducers, internal parts of components and other cables other than those previously specified by the manufacturer. This can result in increased emission or decreased electromagnetic immunity and result in improper operation.



Portable RF communication equipment (including peripherals such as antenna cables and external antennas) should not be used within 30 cm of any part of the equipment, including cables specified by the manufacturer. Otherwise, performance degradation of this equipment may occur.



To maintain basic safety from electromagnetic disturbances during the expected life, always use the equipment in the specified electromagnetic environment and follow the maintenance recommendation described in this manual.



The pins, connector sockets or elements that carry the ESD warning symbol must not be touched or connected without ESD protection measures.



CINTERQUAL - Soluções de
Comércio Internacional, Lda.
Avenida Defensores de Chaves, Nº 4
Escritório Idea Spaces
1000-117 Lisboa, Portugal

NUM. REG. ANVISA: 10069210062

