

English

**OWNER'S  
MANUAL**  
SYNCRUS G3  
WATER UNIT

CE

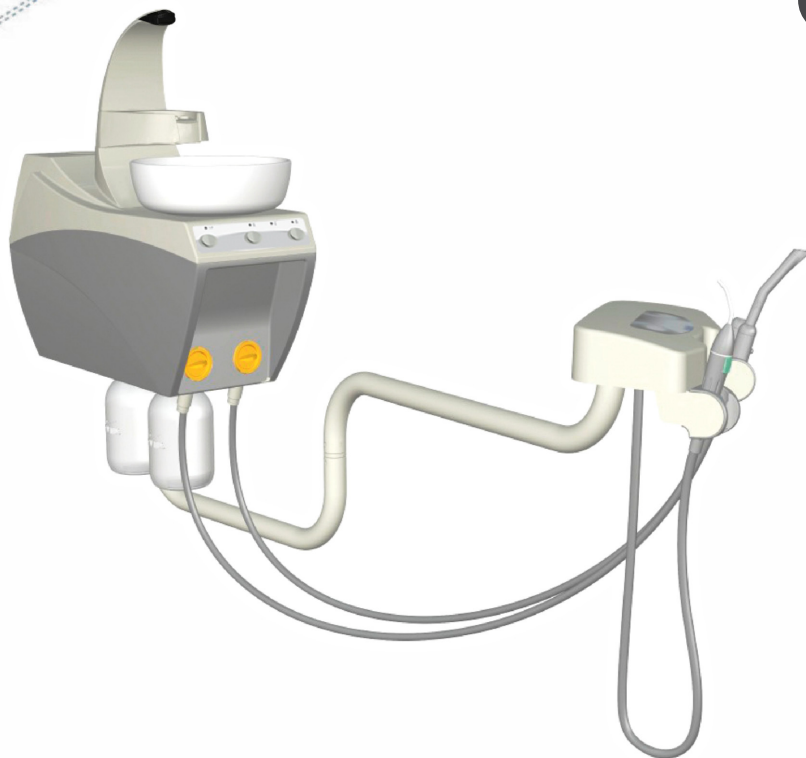

**PAGE INTENTIONALLY LEFT BLANK**

### PRESENTATION OF THIS MANUAL

**Technical Name:** Dental Water Unit

**Trade Name:** Dental Water Units

**Models:** Syncrus G3

**Brand:** Saevo

**Technical Manager:** Daniel R. de Camargo

CREA-SP: 5062199650

**ANVISA Registration No.:** 10069210063



Alliage S/A Industrias Médico Odontológica  
Rodovia Abrão Assed, Km 53 + 450m - CEP 14097-500  
Ribeirão Preto - SP - Brazil  
Phone: +55 (16) 3512-1212



CINTERQUAL – Soluções de Comércio  
Internacional, Lda.  
Avenida Defensores de Chaves, Nº 4  
Escritório Idea Spaces  
1000-117 Lisboa, Portugal



77000000686 - Rev.: 05 - March/22

Document originally written in Portuguese.

### **TRADEMARKS**

All terms mentioned in this manual that are known trademarks, registered trademarks or service marks have been appropriately labeled as such. Other products, services or terms that are mentioned in this manual may be trademarks, registered trademarks or service marks of their respective owners. Alliage S/A makes no claims regarding these trademarks. The use of a term in this manual should not be considered to influence the validity of any trademark, registered trademark or service mark.

Copyright © 2019 Alliage S/A. All rights reserved.

The performance characteristics provided in this manual are for reference only and should not be considered as guaranteed specifications.

## TABLE OF CONTENTS

<b>01</b>	<b>GENERAL INFORMATION</b>	<b>08</b>
1.1.	DEAR CUSTOMER	08
1.2.	INDICATIONS FOR USE	08
1.3.	CONTRAINDICATION	08
1.4.	SYMBOLOLOGY	08
<b>02</b>	<b>WARNINGS, CAUTIONS AND RECOMMENDATIONS</b>	<b>13</b>
<b>03</b>	<b>SYSTEM GENERAL DESCRIPTION</b>	<b>18</b>
3.1.	SYSTEM DESCRIPTION	18
3.2.	APPLICATION SPECIFICATION	18
3.2.1.	Operating principles	18
3.2.2.	Significant physical characteristics	18
3.2.3.	User Profile	19
3.3.	INTENDED MEDICAL INDICATIONS	19
3.4.	PRODUCT MAIN COMPONENTS	20
3.4.1.	Unit	20
3.4.2.	Accessories	21
3.5.	PARTS APPLIED	24
3.6.	LABELS POSITIONING	24
3.7.	SYSTEM REQUIREMENTS	25
3.7.1.	Compressor requirements	25
3.7.2.	Vacuum pump requirements	25
3.7.3.	Installation location	27
3.8.	SYSTEM LAYOUT	27
<b>04</b>	<b>OPERATION</b>	<b>29</b>
4.1.	INITIAL PREPARATION	29
<b>05</b>	<b>CLEANING, DISINFECTION AND STERILIZATION</b>	<b>36</b>
5.1.	CLEARANCE OF THE SUCTION SYSTEM USING VACUUM PUMP	37
5.2.	CLEANING THE SUCTION FILTERS	37
5.3.	CLEANING DRAINS	37
5.4.	BOWL CLEANING	37
5.5.	BIO-SYSTEM	38
<b>06</b>	<b>PROBLEMS DIAGNOSTICS</b>	<b>40</b>
6.1.	TROUBLESHOOTING	40
<b>07</b>	<b>INSPECTION AND MAINTENANCE</b>	<b>43</b>
7.1.	PERIODIC INSPECTION	43
7.2.	PREVENTIVE MAINTENANCE	43
7.3.	CORRECTIVE MAINTENANCE	44
7.4.	ALLIAGE AUTHORIZED SERVICE NETWORK	45
<b>08</b>	<b>WARRANTY</b>	<b>47</b>
<b>09</b>	<b>STANDARDS AND REGULATIONS</b>	<b>49</b>
<b>10</b>	<b>TECHNICAL SPECIFICATIONS</b>	<b>51</b>
10.1.	EQUIPMENT CLASSIFICATION	51

**TABLE OF CONTENTS**

10.2. DEVICE INFORMATION	51
10.3. SPECIFIC INFORMATION	52
10.4. LED CURING LIGHT SPECIFICATION	53
10.5. INTRAORAL CAMERA SPECIFICATIONS	53
10.6. INDUCTION CHARGER SPECIFICATIONS	54
10.7. ENVIRONMENTAL CONDITIONS	54
10.8. EQUIPMENT DIMENSIONS	55
<b>11. ELECTROMAGNETIC COMPATIBILITY</b>	<b>57</b>
11.1. ORIENTATION AND DECLARATION FOR ELECTROMAGNETIC EMISSIONS	57
11.2. ORIENTATION AND DECLARATION FOR ELECTROMAGNETIC IMMUNITY	58

## GENERAL INFORMATION

## 1. GENERAL INFORMATION

### 1.1. DEAR CUSTOMER

Congratulations on your excellent choice. By purchasing equipment with ALLIAGE quality, you can be assured of acquiring products with a technology compatible with the best in the world in its class. This manual provides you with a general presentation of your equipment, describing important details that may guide you in your correct use, as well as in solving small problems that may occur. This manual should be read in full and kept for future reference.

### 1.2. INDICATIONS FOR USE

The Dental Water Units are intended for auxiliary work as a water supply for the realization of dental practices, and the same is for exclusive dental use.

### 1.3. CONTRAINDICATION

There is no known contraindication for this equipment.

### 1.4. SYMBOLOGY

The following symbols are used both throughout this manual and in the product. Make sure that you fully understand each symbol and follow the accompanying instructions.



Fragile, handle with care



Maximum stacking



Protect from rain

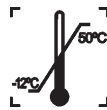

Temperature limit



This side up



Do not step



Keep away from sunlight



Do not reuse





Recyclable



Sterilizable in a steam sterilizer (autoclave) at specified temperature



Parts applied type B



It indicates that the product should be taken to a special garbage collection location at the end of its useful life. It applies to both the device and accessories



Attention



Electrostatic Sensitive Devices (ESD)



Protective ground



Action required



Follow the instructions for use



General warning



Warning  
High voltage



Bio-system activation



Spray cooling



USB Camera Output



Active amalgam separator



Master Valve (Water and air cut-off switch)



Reflector activation



Water supply network/reservoir selector switch



Inversion of the electric micromotor rotation direction



It descends the seat



It ascends the seat



It ascends the backrest



It descends the backrest



Saliva suction controllable valve (Venturi)



Water activation in the bowl



Ejector with controllable valve (Vac-plus)



Water activation in cup holder



Beep



Amalgam separator - Interrupted function



Water heating drive.



Induction charger



Authorized Representative in the European Community



It indicates that equipment complies with Directives 2011/65/EU and 2015/863/EU on the Restriction on the use of certain hazardous substances in electrical and electronic equipment.

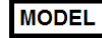

Model



Catalog number



Model number



Serial number



Manufacture Date







Manufacturer

## **WARNINGS, CAUTIONS AND RECOMMENDATIONS**

## 2. WARNINGS, CAUTIONS AND RECOMMENDATIONS

### General warnings



	Please read and understand all instructions contained in these instructions for use before installing or operating this equipment.
	Use only the equipment in perfect condition and protect yourself, patients and third parties from any hazards.
	This equipment must be installed and operated by personnel familiar with the necessary precautions.
	The Dental Water Unit has 4 different interactions with the user, they are: - Identification label: Located on the side of the equipment; - Safety symbologies: Located at the dangerous places and on their identification label; - Foot controller control: located on the swing arm; - Water flow regulators.

### During transportation

The equipment must be transported and stored, observing the following:

- Handle care to avoid falls, excessive vibrations and impacts;
- The packing arrows should be pointing upwards;
- To handle the package as a single unit, consider the center of the gravity indicator;
- Do not stack above the quantity indicated on the package;
- Do not walk or stand on the package;
- Protect against sunlight, moisture, water and dust;
- Observe the temperature, pressure and relative humidity limits.

### During the equipment installation

	The installation instructions can be found in the service manual, accessible only to authorized technicians.
	The equipment must be installed only by the authorized technician. This is a technical procedure that cannot be performed by the user.



To avoid the risk of electric shock, this equipment must only be connected to a supply main with protective earth.



Before turning on the equipment make sure that it is connected at the correct voltage.

- The equipment should only be installed by authorized technical assistants.
- The recommendations of the service manual should be followed as to the mandatory existence of protection grounding.
- Install the equipment in a place where it will not be in contact with moisture, water, plants and animals.
- Install the equipment in a location where it will not be damaged by pressure, temperature, humidity, direct sunlight, dust, airs or corrosive products.
- This equipment is not designed for use in the presence of vapors from flammable anesthetic mixtures or nitrous oxide.
- Place any other external devices at least 1.5 meters away from the equipment, so that the patient cannot touch any other external device while he/she is being serviced.
- The recommendations in this manual for EMC should be followed. Communications equipment and RF-generating sources can affect the operation of the equipment.
- The equipment may cause radio interference or interrupt the operation of nearby equipment, and it is necessary to take mitigating measures, such as reorientation, relocation of equipment or shielding the place.

### Before using the equipment

To help ensure proper hygiene and protect against infectious diseases, prior to first use, the equipment should be cleaned and disinfected following the instructions contained in this manual.

### When using the equipment

- Under no circumstances can the patient operate the equipment.
- The patient should not touch other parts other than those specific to be attended.
- The equipment should be operated only by qualified health professionals.
- While operating the equipment, the operating personnel must:
  - Read and understand the user manual
  - Be familiar with the structure and fundamental functions of this equipment.
  - Be familiar with the emergency situation protocols of this equipment.
  - Be able to recognize irregularities in the operation of the equipment and implement the appropriate measures when necessary.
- The equipment is designed according to electromagnetic compatibility standards, but in very extreme conditions, it may interfere with other equipment. Do not use this equipment in conjunction with other devices that are very sensitive to interference or with devices that create high electromagnetic disturbances.

## Owner's Manual

---

- Do not place the patient on the equipment while starting the equipment, as the patient may be injured if the equipment does not work properly. If there is an error that requires turning the equipment off and on, remove the patient before turning it back on.
- In case of risk to the patient, press the emergency button immediately located on the side of the equipment.
- If this product is exposed to water, moisture or foreign substances, turn it off immediately and contact an Alliage Authorized Service Center.
- In case of damage or defect, do not use the equipment and contact an Alliage Authorized Service Center.
- Do not use the equipment if any of its compartments or parts are damaged, loose, or removed. Contact an Alliage Authorized Service Center and request repair or replacement of any damaged, loose, or removed enclosures or parts of the equipment before using the equipment again.
- Do not touch the equipment or use it if it is being repaired or if the equipment cabinets have been removed.
- Do not open or remove any of the cabinets from the equipment. No internal part can be user-reparable.
- In case of fall or impact of moving parts causing the breakage of the same, be careful when handling them, there may be severe parts.
- This equipment does not produce physiological effects that are not obvious to the operator.
- The operator cannot contact the patient when in contact with accessible connectors.
- The operator cannot use tools to open the equipment.

### Prevention against cross-contamination



Appropriate cleaning and disinfection/sterilization measures should be taken to avoid cross-contamination between patients, users and others.

- For each new patient, perform the procedures of cleaning, disinfection/sterilization and according to the instructions contained in this manual.

### After using/operating the equipment

- Turn off the equipment if not in use for a long time.
- All parties that have had contact with the patient should be cleaned and disinfected/sterilized to each new patient to avoid transmission of infectious agents that may cause serious diseases.
- Clean and disinfect/sterilize as instructed in this manual.
- Do not unplug the cable or other connections without needing to.
- Do not modify any part of the equipment.

### Precautions in case of change in the equipment operation

If the equipment has any abnormalities, check to see if the problem is related to an item listed in the "Problems Diagnostics" topic in this user manual.

If the problem cannot be resolved, turn off the equipment, contact an Alliage Authorized Service Center.

- The heater can only be changed by the authorized Alliage Service Provider.



The manufacturer is NOT responsible for:

- The equipment is used for purposes other than those for which it was designed.
- Damage caused to the equipment, operator and/or patient as a result of incorrect installation and maintenance procedures in disagreement with the operating instructions accompanying the equipment.

### Precautions for reducing environmental impact

Alliage S/A aims to achieve an environmental policy to promote the supply of environmentally conscious medical and dental products that continuously minimize environmental impact and are more environmentally friendly to the environment and human health.

To maintain a minimal impact on the environment, please note the recommendations below:

- After installation, forward the recyclable materials to the recycling process.
- During the life cycle of the equipment, turn it off when it is not in use.
- To prevent environmental contamination, the disposal of waste and consumables should follow the normal procedure for biomedical waste.

Biomedical waste includes non-acute materials likely to cause disease or suspected of harboring pathogenic organisms that must be stored in a yellow bag properly labelled with a symbol of biological risk, stored in a puncture-resistant container, watertight, until collection and incineration.



The Equipment packaging consists of wood, cardboard, plastic and expanded polyurethane (PU) which are 100% recyclable materials.

DIMENSIONS:

Main unit: 920 X 840 X 560mm / MASS: Approximately: 20 Kg

### Precautions in case of equipment being unused

To avoid environmental contamination or misuse of the equipment, when it is unused, it must be disposed of (according to current legislation) in an appropriate place, because the materials inside it can contaminate the environment.

For the European Economic Area (EEA), this product is subject to Directive 2012/19/EU as well as the corresponding national laws. This policy requires that the product should be taken to a special garbage collection location at the end of its useful life. It applies to both the device and accessories. Contact the dealer if the final disposal of the product is required.



This equipment should not be disposed of as household waste.



## SYSTEM GENERAL DESCRIPTION

### 3. SYSTEM GENERAL DESCRIPTION

#### 3.1. SYSTEM DESCRIPTION

Water Unit for dental use, for auxiliary work such as water supply for waste collection and activation of spittoon and ejector.

#### 3.2. APPLICATION SPECIFICATION

The Dental Water Units are intended for auxiliary work as a water supply for the performance of dental practices, and the same is for exclusive dental use.

##### 3.2.1. Operating principles

Coupled to the chair, with electronic control panel, which activates the functions water in the bowl, water in the cup holder, activation of the Bio-System, chair emergency stop, \*3-way syringe water heating and \*reservoirs luminosity.

Programmable timer for the activation of water in the cup holder and spittoon for a time interval defined by the professional, providing great water savings in the dental chair.

##### 3.2.2. Significant physical characteristics

Structure of the set constructed of steel with ABS body injected with anti-UV protection. Plain high-gloss epoxy-based paint, polymerized in an oven at 250°C, with corrosion resistant phosphatized treatment and cleaning materials.

Upper body of the unit, with adequate location for better spitting position, with 180° folding bowl providing total comfort to the patient.

Ceramic spittoon bowl, deep and easy to remove for hygiene and asepsis, accompanies drain for solids retention.

Water flow adjustment system that allows a fine adjustment in the water flow of the bowl and cup holder.

It has a debris filter facilitating cleaning and disinfection.

Ejectors with automatic activation of easy handling, which provide excellent operational performance, allow the professional a better visualization of the operative field with reduction of the risk of aerosol contamination and greater comfort to the patient.

High-power ejectors with low-voltage individual electric drive, provides lightness and drive accuracy.

Triple rotary nozzle syringe, removable and autoclavable. Dual system for water supply (mains/reservoir). Master valve (switch for cutting the water).

Amalgam separator: system consisting of separating particles from the amalgam from the secretion. Heavy metal extremely harmful to the environment.

Swing arm with bilateral handle: terminals holder with wide horizontal movement that allows the ideal approach to the operative field and excellent accessibility to the various available resources. It optimizes work by prioritizing ergonomics and biosafety.

Automatic selection of tips through individual pneumatic valves, enabling lightness in their activation. Bio-System: disinfection system, which provides internal cleaning of hoses and terminals through bactericidal liquid, preventing risks of cross-contamination.

---

\* Optional items

### 3.2.3. User Profile

The Dental Water Unit can be used by both sexes, with the minimum level of literacy with the ability to read and understand images, symbols, icons, Western characters (Arial font), numerical alpha characters, and may not present a degree of visual imperfection for reading or vision and average degree of impairment of recent memory, not being in clear capacity to perform the activities and functions of the product in the correct manner the profession. The user needs to be a qualified health professional and trained to perform the activities, functions frequently used in the application of the Dental Water Unit and its functions of primary operations.

### 3.3. INTENDED MEDICAL INDICATIONS

The Dental Water Units are intended to assist in the work of caries removal, removal of restorations and odontosection, as an aid in the extraction of teeth, also indicated for oral burning syndrome, dental abscesses, dental abrasion, among others linked to dental treatment.

### 3.4.PRODUCT MAIN COMPONENTS

#### 3.4.1.Unit



The contents of this page are of an informative nature, the equipment being able to differ from that illustrated. So, upon acquiring the product check the technical compatibility between equipment, coupling and accessories.

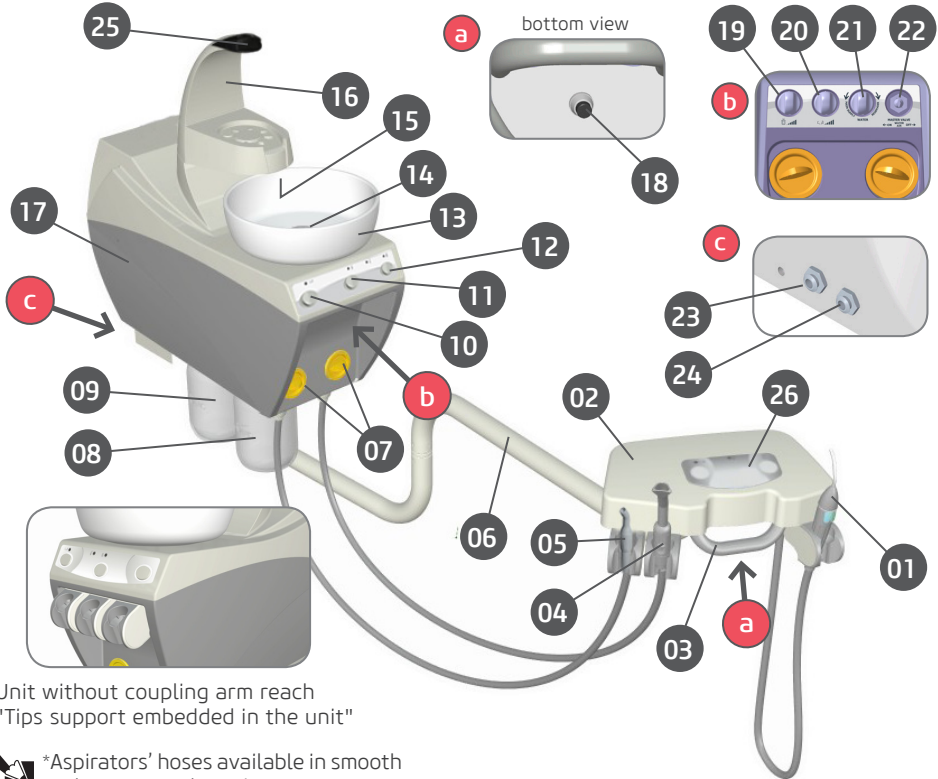

Unit without coupling arm reach  
"Tips support embedded in the unit"



\*Aspirators' hoses available in smooth and corrugated versions.

- \*01 - Triple syringe
- \*02 - Access Cover
- \*03 - Front Handle
- \*04 - Vacuum pump sucker
- \*05 - Venturi type sucker
- \*06 - Arm reach
- 07 - Sucker Filters
- \*08 - Bio-System tank
- 09 - Water tank
- \*10 - Bowl water drive
- \*11 - Syringe water heating drive
- \*12 - Glass Water supply
- 13 - Bowl
- 14 - Drain cover
- 15 - Water tank tubing
- \*16 - Glass feeder
- 17 - Cabinet body
- \*18 - Bio-System Drive
- 19 - Adjust water flow for Glass feeder
- 20 - Adjust water flow for the bowl
- \*21 - Water selector valve - tank / network
- \*22 - Master valve - releases / blocks water flow
- \*23 - Quick coupling for air outlet
- \*24 - Quick coupling for water outlet
- \*25 - Optical Sensor
- \*26 - Control panel

\* Optional items

3.4.2. Accessories

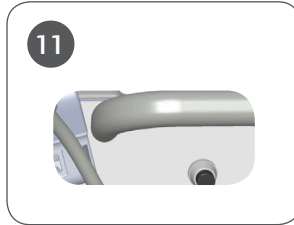
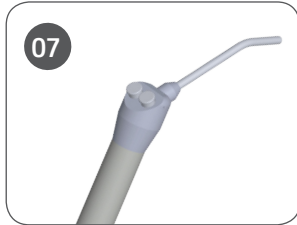
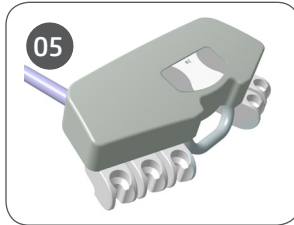
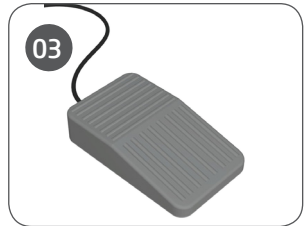
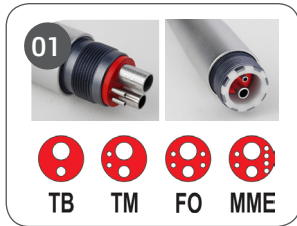

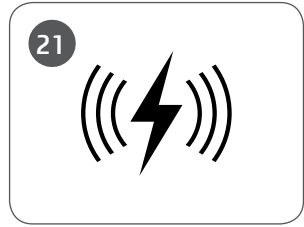
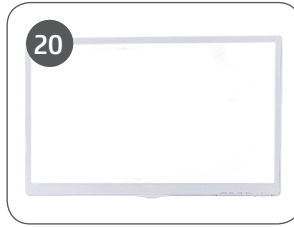
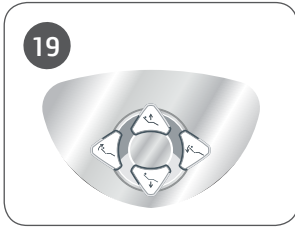

\*01. Terminals:

- Borden (TB)
- Midwest (TM)
- Fiber Optic (FO)
- Electric Micromotor (EMM)

\*02. LED curing light

\*03. Bowl or cup holder water trigger foot controller

\*04. Bicarbonate jet kit (Jet Hand model)

\*05. Swing arm coupling with capacity for up to 5 tips

- Available in versions with and without articulation

\*06. Swing arm coupling with capacity for up to 3 tips

- Available in versions with and without articulation

\*07. 3-way syringe with fully metallic body or with handle injected in thermoplastic

\*08. 3-way syringe with body fully injected in thermoplastic

\*09. Cup holder water conductor (2 models)

- Available in versions with and without optical sensor

\*10. Injectors with a fully metallic body or injected in thermoplastic:

- Venturi type injector
- High-performance Venturi injector
- Bigger injector for Vacuum Pump
- Smaller injector for Vacuum Pump
- Brush for cleaning the injector
- Suction cannula

\*11. Bio-System Activation

\*12. Water selector valve - reservoir/mains

\*13. Master valve (System that allows cutting the water and air flow to the dental chair)

\*14. Intraoral Camera Kit

\*15. Bowl made of injected material

\*16. Progressive foot controller

\*17. Progressive foot controller with water activation/cut

\*18. Heater kit for 3-way syringe

\*19. Swing arm control panel

\*20. Multimedia Kit

\*21. Induction charger

\*Optional Items (Subject to commercial availability)

## The units may consist of:

	Optional	Abbreviations
1 BV Ejector		TBV
1 Venturi Ejector		TV
1 Venturi Ejector + 1 BV Ejector		2T
2 Venturi Ejectors		2 TV
2 BV Ejectors		2T BV
1 Syringe + 1 Venturi Ejector		S TV
1 Syringe + 1 BV Ejector		S TBV
1 Syringe + 1 Venturi Ejector + 1 BV Ejector		3T
1 Syringe + 2 Venturi Ejectors		3T V
1 Syringe + 2 BV Ejectors		3T BV
1 Syringe + 1 Photo + 1 High Rotation Terminal + Micromotor Terminal + 1 Venturi Ejector		5T
1 Syringe + 1 Photo + 1 High Rotation Terminal + Micromotor Terminal + 1 BV Ejector		5T BV
LED curing light		OPTI
Terminal Borden		TB
Terminal Midwest		TM
Fiber Optic Terminal		FO
Electric Micromotor Terminal		EMM
Cup Holder		E
Intraoral Camera		CAM
Swing arm		ALC
Electronic panel drive		P
Full Equipment		FULL

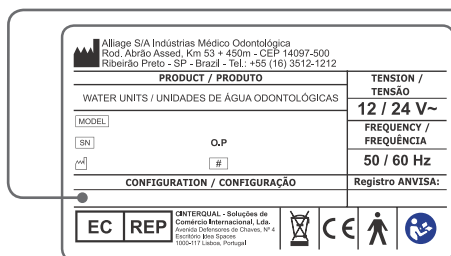

Identification label "responsible field in identifying product configuration".

## 3.5.PARTS APPLIED

The following item is used in the patient treatment

Type of parts		Type of contact	Contact duration	Classification
Ejector cannula	Detachable	Mucous membrane	1 min	N/A
Syringe nozzle	Detachable	Mucous membrane	1 min	N/A

\* Not supplied with the product.

## 3.6.LABELS POSITIONING

The following figure illustrates the labels location on the equipment.



Illustrative image

<b>a</b>	
Alliage S/A Indústrias Médico Odontológica Rod. Abílio Assad, Km 53 + 450m - CEP 14097-500 Ribeirão Preto - SP - Brazil - tel.: +55 (16) 3512-1212	
<b>PRODUCT / PRODUTO</b>	
WATER UNITS / UNIDADES DE ÁGUA ODONTOLÓGICAS	<b>TENSION / TENSÃO</b>
MODEL	<b>12 / 24 V~</b>
SN	<b>FREQUENCY / FREQUÊNCIA</b>
O.P. <input type="checkbox"/> # <input type="checkbox"/>	<b>50 / 60 Hz</b>
<b>CONFIGURATION / CONFIGURAÇÃO</b>	
<b>Registro ANVISA:</b>	
<b>EC REP</b>	ENTERGUAL - Soluções de Comércio Internacional, Lda. Avenida Saldanha de Craveiro, Nº 4 Edifício Ivo Siqueira 1000-017 Lisboa, Portugal





### 3.7.SYSTEM REQUIREMENTS

#### 3.7.1.Compressor requirements

The compressor is required to provide compressed air for clinical and laboratory use, having stable performance and flow capacity according to the minimum requirements required for the installation of the dental chair, besides being free of oil or emission of fumes, vapors or unpleasant odors.

It must have a valve safety system that comes into operation for pressure release in the event of a pressure failure and also an overload protector for the purpose of protecting the equipment from overheating. The location of its installation should be an airy place, preferably outside the office and should not be installed in sanitary facilities such as bathrooms and toilets, to minimize contamination of the air used in the dental chairs.

For patient, operator safety and the perfect operation of the product, the compressor installation must comply with the following recommendations:

Install a pressure relief device with the compressor;

Install air filter with pressure regulator, thus preventing oil, moisture and solid particles from penetrating inside the dental chair and then reaching its vital parts, for example; valves, handpieces, etc.;

Install the compressor near the power point to avoid losses;

In the installations preferably use rigid copper pipes. Pipes can also be executed with galvanized steel tubes, stainless steel, nylon or polyethylene.

Pressure limit of 80 psi; Limit flow rate  $\geq 47$  NL/min;

Humidity limit between 40% and 60%;

Oil contamination limit of 0.5 mg/m<sup>3</sup>;

Particle contamination limit of < 100 particles/m<sup>3</sup> (particles of size between 1 and 5 $\mu$ m);

Air quality regulations comply with the laws of each country.

#### 3.7.2.Vacuum pump requirements

The Vacuum Pump is required to have high suction power, to allow the professional a better visualization of the operative field with reduced risk of aerosol contamination and greater comfort to the patient, avoiding its constant displacement to the water unit during the clinical procedure. The proper functioning of the Vacuum Pump is indispensable to ensure infection control in the dental chair and asepsis of the patient's oral cavity, as it vacuum and drains the residuals from the mouth out of the dental chair. Larger parts of the solids should be retained in a debris separator, from which they should be removed daily.

The Vacuum Pump must be installed in a place where it will not be damaged by pressure, temperature, humidity, direct sunlight, dust or salts. The equipment should not be subjected to tilting, excessive vibration, or shock (including during transport and handling).

The suction power must be regulated by a stopcock according to the dental chair need and the motor must have a thermal protector, which turns off the equipment in case of overheating and prevents the motor from burning.

The Vacuum Pump must have a minimum vacuum pressure of 75 mmHg so that the ejectors have a sufficient suction power for mouth cavity aspiration and the value for the maximum vacuum pressure should be 500 mmHg per dental chair installed.

To considerably increase the service life of its components, the materials used in manufacturing must be highly resistant to corrosion.

For patient, operator safety and the perfect operation of the product, the installation of the Vacuum Pump must comply with the following recommendations:

The equipment is not designed for use in environments where vapors, flammable anesthetic mixtures with air, or oxygen and nitrous oxide can be detected;

The equipment must be grounded correctly;

Although this equipment has been designed according to electromagnetic compatibility standards, it

can, in very extreme conditions, cause interference with other equipment. Do not use this equipment in conjunction with other devices that are very sensitive to interference or with devices that create high electromagnetic disturbances;

Do not submit to plastic parts for contact with chemical substances used in dental treatment routines.

Such as: acids, mercury, acrylic liquids, amalgams, etc.;

Avoid pouring water or other liquids into the equipment, which could cause short circuits; Before starting the operation of the Vacuum Pump, make sure that the voltage input cable plug is plugged into the mains, and that the water supply stopcock is open;

The lack of water will result in damage to the mechanical seal and the Vacuum Pump will not vacuum;

Never use detergent or any sparkling product to clean the vacuum pump suction tubes internally;

Do not modify any part of the equipment. Do not unplug the cable or other connections without need;

Before cleaning the equipment, turn off the master switch;

Do not use microabrasive material or steel straw in cleaning, do not use organic solvents or detergents containing solvents such as ether, stain strip, etc.;

To avoid the risk of infection, wear protective gloves when handling filters and drains. Dispose of contaminated waste and products in biological waste;

Never use sparkling products in suction (Descaling, Detergents, Flotators, etc.), this procedure may damage the internal parts of the Vacuum Pump motor;

Never use the bleach solution for external cleaning of the Vacuum Pump and/or any equipment, as this mixture is highly corrosive and may damage metal parts.

## 3.7.3. Installation location



To meet safety standards, do not operate non-medical equipment, such as personal computers, within the patient area. Outside the patient's area, the presence of non-medical equipment is acceptable, provided that approved and certified computer equipment is used.

Computer equipment must be EC approved and must comply with EC 60950-1:2005 + AMD1:2009 + AMD2:2013 and low voltage and 2014/EU low voltage and 2014/30/EU guidelines 2014/EU

## 3.8. SYSTEM LAYOUT



\* Do not accompany the product

# 4

## OPERATION

## 4. OPERATION

### 4.1. INITIAL PREPARATION

	The equipment should be cleaned and disinfected prior to use in a new patient, observing the instructions contained in this manual.
---	---

	To insulation the power supply equipment, use the master switch.
---	--

### Control Panel

- 01 - Water triggering in the Bowl\*
- 02 - Water triggering in the cup holder\*
- 03 - Water triggering heating syringe\*

#### Attention:

To set the time of water flow in the Bowl (01) / cup holder (02), hold the corresponding key, 3 short beeps will be displayed indicating the programming mode. Release the key after the desired time interval. The flux time is recorded.

The maximum time for programming is 60 seconds, exceeding this limit will beep an error indicating that the time has not been programmed.

When turning the key "triggering heating water syringe" (03), the LED will turn on (a) starting the heating of syringe water. The temperature must remain around 40° C. To turn off the "trigger water heating", press (03) again.

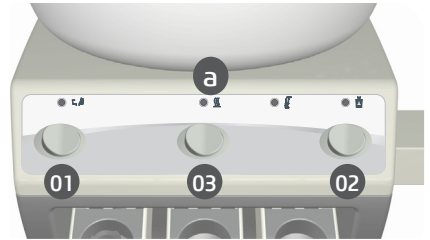

### Water activation in the bowl through the "optical sensor\*"

The water activation is done automatically through the optical sensor with the simple approximation of the patient, providing greater practicality in operation.

### Ejectors activation

When removing the ejector from the tip holder (BV or Venturi), it will start operating automatically.

BV ejectors have adjustment of the suction flow as per your need, it is done through the lever attached to the ejectors, moving up or down.

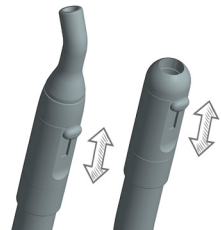

\* Optional items



### 6.5mm cannula coupling

The cannula coupling curve is designed for better handling, but can also be cut at the indicated location with the aid of a cutting object.

### Replacement of the cannula coupling pattern

If the cannula (a) is required to be used in the BV ejector, replace the cannula coupling according to the procedure below:

Remove the coupling (b) by unscrewing it from the BV ejector assembly.

Screw the coupling (c) into the BV ejector assembly and attach the cannula coupling.

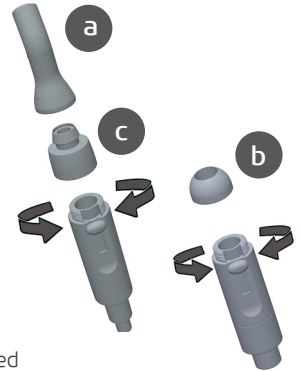

### "High and low rotation TB/TM terminals"\* spray adjustment

The adjustment is done through a record positioned in the terminal. Rotate it to decrease or increase the spray.

Note: Since it does not have spray, the "TB" double terminal does not need adjustment.

### 3-way syringe use\*

Press the button (a) to get out water, (b) to get out air or both simultaneously to get spray.

### Water heating activation\*

When you turn on the key "hot water activation" (d), LED will light (c), starting to heat water from the syringe. Temperature should remain about 40 °C. To turn off the "water heating activation" function, press key (d) again.

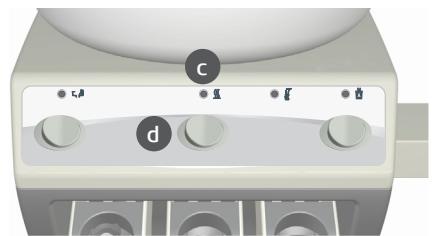
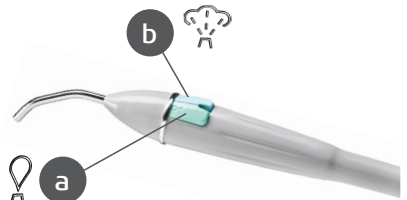

\* Optional items

## Terminals activation

### Progressive foot controller\* (fig.1)

For operate rotating instruments, remove the instrument to be used from the stand, activate the control foot controller (b).

Fig.1

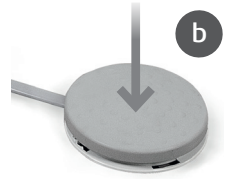

### Progressive foot controller with chip-blower function/ handpiece water lock system\* (fig.2)

For operate rotating instruments, remove the instrument to be used from the stand, activate the control foot controller (b).

Fig.2

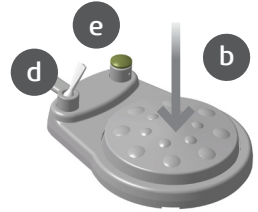



To trigger the handpiece water lock system, place the switch (d) in Off to unlock. Return to the starting position to lock. Pressing the (e) down key will trigger air on the tips.

### Foot controller chip-blower\* (fig.3)

For operate rotating instruments, remove the instrument to be used from the stand, activate the control foot controller (b).

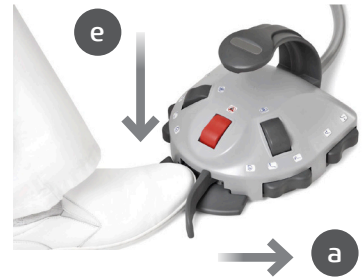
Fig.3



 The power (air supply) can be controlled by the operator with greater or lesser pressure on the foot controller lever (a). The "chip-blower" system allows the release of airflow with the turbine down (air function).

Pressing the (e) down key will trigger air on the tips. Pressing the (e) key down and shifting the lever to the right together will trigger the high-speed air and water turbine (spray).

## Bio-System Activation\*

Remove the handpieces from the terminals. Take the handpiece terminals to the sink or bowl of the water unit. Fully open terminals spray stopcocks. Activate the Bio-System activation key for a few seconds to internally disinfect the components of the Instruments Unit with bactericidal liquid. Then, press the foot control for a few seconds to rinse, to eliminate the chemical residues of the bactericidal liquid retained internally in the components of the Instruments Unit.



### Warning

- This procedure must be done at the beginning of the day and after each patient.

\* Optional items

## Activation through the swing arm control panel\*

- 15 - Drive up the seat.
- 16 - Drive down the seat.
- 17 - Drive up the backrest.
- 18 - Drive down the backrest.

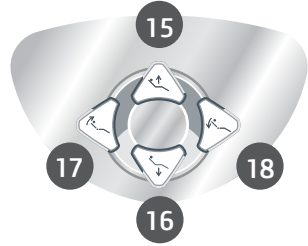

## Water flow adjustment

- 01 - Cup filler adjustment
- 02 - Bowl flush adjustment

To regulate the bowl flush and cup filling water flow, use the bowl flush adjustment (02) and the cup filler flow adjustment (01), to increase flow, turn it anticlockwise, to decrease, turn in clockwise.



## Regulation of the water selecting valve\*

To regulate this kind of water feeding, please use the selecting valve (03) to select the feeding through the reservoir and turn around in the clockwise sense. To select the feeding through the net, turn around counter clockwise sense.

## Master Valve\*

The master valve is a safety device that aims to block / release the entry of water to the dental set. It is of utmost importance to have interrupted the water supply to the dental set in the end of the working day, which can be done through the key (ON/OFF) (04).

---

\* Optional items



LED curing light\*

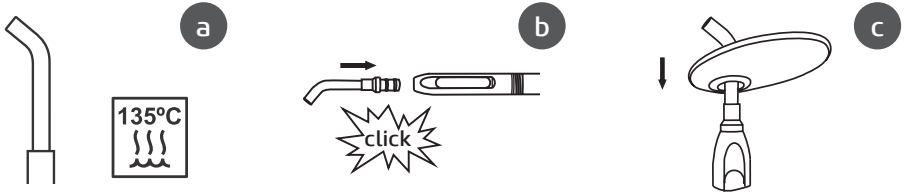

a - Before using, please sterilize the light conductor, disinfect the handpiece and the cable.

b - Insert the light conductor into the handpiece until you hear a slight click and feel that it has fitted correctly.

c - Insert the eye protector into the light conductor.



**Attention**

Always keep the light conductor protected by disposable PVC film that must be changed for each patient. This procedure protects the light conductor against scratches and the accumulation of undesirable residues.

- Press the button to turn on the equipment (01)
- Select the application mode by pressing the selection button (02), the variations of which are:
  - **Continuous:** Maximum and continuous light intensity mode (same luminosity from the beginning to the end of the polymerization).
  - **Ramp:** Gradually light intensity increases gradually.
  - **Pulsed:** Pulsed mode are cycles that oscillate at a fixed frequency.
- The chosen application mode will be shown on the display.
- To program the time, press the button (03) and choose the time from 5 to 20 seconds, which will be shown on the display (04).

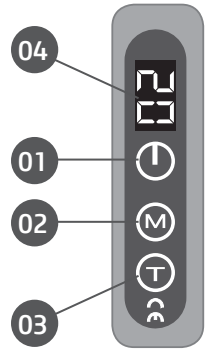

Use the polymerization time recommended by the composite resin manufacturer and always perform restorations in incremental layers with a maximum thickness of 2mm.

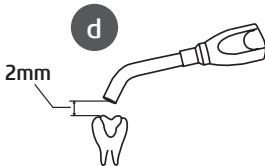

d - After selecting the application mode and choosing the time, remove the protective cover from the light conductor, bring the handpiece to the patient's mouth and position the light conductor at a safe distance.

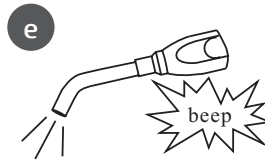

e - To start the polymerization cycle, press the trigger button. To interrupt, just press again.

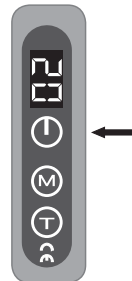

\* Optional items



### Warnings

- Never direct the beam of blue light at your eyes;
- Protect the visual field using the Eye Protector;
- The Eye Protector has the objective of filtering only the blue light that acts in the photopolymerization of resins to protect the vision and still allows the ambient lighting to pass into the operative field.



### Auto shutdown:

The equipment will automatically turn off when not in use for more than 3 minutes. To turn it back on, press the power button.

## How to provision the reservoirs

### Water - Syringe/Handpieces

Remove the reservoir (b) uncoiling it on clockwise and make the replacement of water. After the replacement put it back coiling on anticlockwise.

Always use filtered water or aseptic products.

### Bio-System\*

Remove the reservoir (a) uncoiling it on clockwise and make the replacement. Use a chlorinated water solution 1:500 Preparing the solution:

From a solution of hypochlorite of sodium at 1%, a solution of chlorine at 500 p.p.m. is prepared.

How to prepare the solution: Take 25ml of hypochlorite of sodium at 1% and dilute it in 500 ml of water (1 to 20). Such solution should be prepared daily.

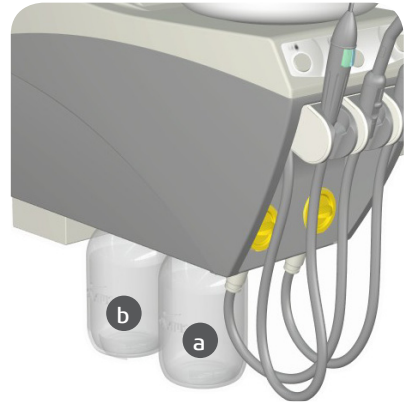

### Warning

- Follow this proportion strictly to avoid damages in the equipment and to have an efficient result in the disinfection.

# 5

## CLEANING, DISINFECTION AND STERILIZATION

## 5. CLEANING, DISINFECTION AND STERILIZATION



Before starting the cleaning and disinfection procedure, turn off the equipment main switch to avoid permanent damage.



For your protection, during the process of cleaning and disinfecting the equipment, use PPE such as disposable gloves and goggles.

The cleaning and disinfection process must be performed at each patient change. When starting the process, check for visible dirt, such as blood or saliva. Carefully clean the patient's entire contact area, such as upholstery lining. For cleaning use a clean, soft cloth moistened with mild soap and then dry with a clean, soft cloth or paper towel. For the disinfection process of the equipment, use a disinfectant detergent foam that has active components based on didecylidimethylammonium chloride. Apply the disinfectant detergent foam on the surface or on a clean cloth and spread it over the surface to be treated. Respect the antimicrobial contact time specified by the manufacturer. After application, allow to dry. Do not rinse off. Some of the removable parts that come in contact with the patient can be autoclaved. These parts are: Syringe nozzle, Injectors cannula.



All accessories suitable for sterilization must be sterilized only in an autoclave at 135 °C with at least 3 minutes of waiting time and with a pressure of 2.2 bar.

If these items are autoclaved, disinfection by alternative methods is not necessary. There is no limit on cycles or application time that the equipment and its parts can tolerate during the cleaning, disinfection and/or sterilization process, following the instructions in this manual.



Do not spill liquid disinfectant on the equipment.



Do not use organic solvents, for example, thinner, to clean the equipment. In the event that the developer solution is spilled on the panel, clean it immediately, as these solutions may compromise the equipment's paint.



Sterilization parameters must always be followed. Accessories that are not properly sterilized can cause disease in patients.

## 5.1.CLEARANCE OF THE SUCTION SYSTEM USING VACUUM PUMP

The manufacturer recommends sucking the disinfectant and disinfectant solution daily, avoiding the risk of cross-contamination and increasing the life of the equipment.

To perform the disinfection of your equipment, we recommend the use of the composition of:

- Active Ingredient: 13.6% Phosphoric Acid
  - Excipient: Isopropyl Alcohol, Acidulant, Dye and Thickener.
- When sucking the solution, it is important that it is carried out in all suction terminals and that they are open. Then remove the suction ducts from the hoses for asepsis (Fig.a). "autoclaving the ejectors cannulas".
- Solution Preparation: Add 30mL of the solution in 1 liter of water. Vacuum the solution with maximum sucking power and also pour the liquid into the water unit bowl.
- In the first use of the solution product, we suggest adding 60mL of the concentrated product in 1 liter of water during the first 5 days to remove accumulated waste.

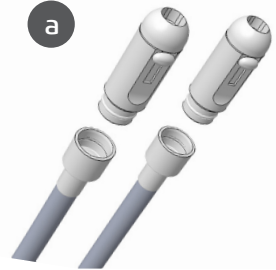

## 5.2.CLEANING OF THE SUCKER AND FILTERS

After the suction of the solution through the ejector, take the lid (01) and the filter (02) and wash them in running water.

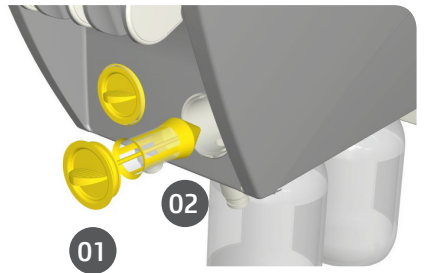

## 5.3.CLEANING DRAINS

Remove the drain (03), then clean and disinfect.

	Wear protective gloves when handling filters and drains. Dispose of contaminated waste and products in biological waste
---	---



## 5.4.BOWL CLEANING

For best results in cleaning the bowl of your equipment, we recommend using the composition of:

Glycolic Acid, Maleic Anhydride, Citric Acid, Ethoxylated Fatty Alcohol, Essence and Water.

Apply the solution to the water unit bowl, use a soft sponge or clean cloth until it removes impurities.

### 5.5.BIO-SYSTEM

Remove the handpieces from the terminals. Take the handpiece terminals to the sink or bowl of the water unit. Fully open terminals spray stopcocks. Activate the Bio-System activation key located on the water unit's control panel for a few seconds to internally disinfect the Water Unit components with bactericidal liquid. Immediately after, activate the control foot controller for a few seconds to rinse to eliminate chemical residues from the bactericidal liquid, retained internally in the components of the Water Unit.



# 6

## PROBLEMS DIAGNOSTICS

## 6. PROBLEMS DIAGNOSTICS

### 6.1.TROUBLESHOOTING

In case you encounter any problem in the operation, follow the instructions below to check and fix the problem, and/or contact your representative.

Unforeseen incident	Probable Cause	Solutions
<ul style="list-style-type: none"> <li>- Ejector with no suction.</li> </ul>	<ul style="list-style-type: none"> <li>- Air deficiency in the compressor.</li> <li>- Filter with excess debris.</li> <li>- Misplaced filter cover.</li> <li>-Container collector of amalgam partially full 95%.</li> <li>-Completely full amalgam collector container.</li> </ul>	<ul style="list-style-type: none"> <li>- Regularize air supply.</li> <li>- Remove and wash filter.</li> <li>- Request maintenance.</li> </ul>
<ul style="list-style-type: none"> <li>- Handpiece with low rotation.</li> </ul>	<ul style="list-style-type: none"> <li>- Dental chair supply pressure below specified (80 PSI).</li> </ul>	<ul style="list-style-type: none"> <li>- Adjust the supply pressure (80 PSI).</li> </ul>
<ul style="list-style-type: none"> <li>- There is no water in the handpieces spray.</li> </ul>	<ul style="list-style-type: none"> <li>-Air deficiency in the compressor.</li> <li>-Lack of water in the reservoir.</li> <li>-Handpiece coupling terminal closed.</li> </ul>	<ul style="list-style-type: none"> <li>-Regularize air supply.</li> <li>-Fill the reservoir with filtered water.</li> <li>-Open the terminal.</li> </ul>
<ul style="list-style-type: none"> <li>- Handpiece does not work.</li> </ul>	<ul style="list-style-type: none"> <li>- Compressor off.</li> </ul>	<ul style="list-style-type: none"> <li>- Start the compressor.</li> </ul>
<ul style="list-style-type: none"> <li>- There is no water in the syringe.</li> </ul>	<ul style="list-style-type: none"> <li>-Lack of water in the reservoir.</li> <li>-Compressor off.</li> </ul>	<ul style="list-style-type: none"> <li>-Fill the reservoir with filtered water.</li> <li>-Start the compressor.</li> </ul>
<ul style="list-style-type: none"> <li>- The bowl and cup holder water activation does not work.</li> </ul>	<ul style="list-style-type: none"> <li>-Water shortage.</li> <li>-Water stopcock closed.</li> <li>-Lack of electricity.</li> <li>-Chair fuse blown.</li> <li>-Chair master switch disconnected.</li> </ul>	<ul style="list-style-type: none"> <li>- Check the water mains.</li> <li>- Open the water stopcock.</li> <li>- Check the electrical network.</li> <li>-Turn off the power to the chair and request the presence of a Technician.</li> <li>-Connect the chair master switch.</li> </ul>
<ul style="list-style-type: none"> <li>- There is no water flow in the bowl when the patient approaches (optical sensor).</li> </ul>	<ul style="list-style-type: none"> <li>- Sensor damaged.</li> <li>- Distance between patient and sensor bigger than 300mm.</li> <li>- Dirt on the sensor lens.</li> <li>- Chair fuse blown.</li> </ul>	<ul style="list-style-type: none"> <li>-Request the presence of a technician.</li> <li>-Approach the sensor (less than 300mm).</li> <li>-Clean the sensor lens.</li> <li>-Turn off the power to the chair and request the presence of a Technician.</li> </ul>



Unforeseen incident	Probable Cause	Solutions
<ul style="list-style-type: none"> <li>- When activating the Bio-System, no bactericidal liquid comes out of the handpiece terminals.</li> </ul>	<ul style="list-style-type: none"> <li>-Lack of liquid in the Bio-System reservoir.</li> <li>-Chair fuse blown.</li> <li>-Chair master switch off.</li> </ul>	<ul style="list-style-type: none"> <li>-Fill the reservoir with bactericidal liquid.</li> <li>-Turn off the power to the chair and request the presence of a Technician.</li> <li>-Turn on the Chairs main switch.</li> </ul>
<ul style="list-style-type: none"> <li>- LED curing light completely inoperative.</li> </ul>	<ul style="list-style-type: none"> <li>-Lack of electricity.</li> <li>-Chair fuse blown.</li> </ul>	<ul style="list-style-type: none"> <li>- Check the electrical network.</li> <li>- Turn off the power to the chair and request the presence of a Technician.</li> </ul>
<ul style="list-style-type: none"> <li>- The equipment is not polymerizing the resins.</li> </ul>	<ul style="list-style-type: none"> <li>- Resin not suitable for the wavelength range of LED curing lights.</li> </ul>	<ul style="list-style-type: none"> <li>- Acquire resin suitable for the LED curing light wavelength, that is, it contains photoinitiators with camphorquinone.</li> </ul>
<ul style="list-style-type: none"> <li>- Completely inoperative intra-oral camera.</li> </ul>	<ul style="list-style-type: none"> <li>-Lack of electricity.</li> <li>-Chair fuse blown.</li> <li>-Camera FREEZE (A) key off.</li> </ul>	<ul style="list-style-type: none"> <li>- Check the electrical network.</li> <li>-Turn off the power to the chair and request the presence of a Technician.</li> <li>-Press the button (A) to turn on the camera.</li> </ul>
<ul style="list-style-type: none"> <li>- The camera lights up, but there's no picture on the screen.</li> </ul>	<ul style="list-style-type: none"> <li>-Monitor off.</li> <li>-Poor connection of the monitor cable.</li> <li>-Video input not selected.</li> <li>-USB cable disconnected.</li> <li>-Camera capture software poorly installed.</li> </ul>	<ul style="list-style-type: none"> <li>- Connect monitor.</li> <li>- Check the monitor cable connection.</li> <li>-Select the video input.</li> <li>-Connect the USB cable.</li> <li>-Install the software correctly.</li> </ul>

If problems persist, contact the Alliage Service Department.

# 7

## INSPECTION AND MAINTENANCE

## 7. INSPECTION AND MAINTENANCE



Maintenance or service procedures may only be carried out by a technical service authorized by the manufacturer.

All instructions for using the equipment as intended are provided in this user guide. If a problem is detected and cannot be corrected with the instructions in the problem diagnostics section, contact the Alliage Service Department.

### 7.1.PERIODIC INSPECTION

It is imperative that this equipment be inspected regularly to ensure operational safety and functional reliability. This inspection must be carried out by personnel familiar with the necessary precautions to avoid exposing the patient to risk.

Periodic inspection should be carried out at regular intervals (at least once a year) to ensure that the product is permanently safe and operational. All components subject to normal wear and tear should be checked and, if necessary, replaced.

The manufacturer and the assembler/installer are exempt from responsibility for the standard results not being compliant in cases where the user does not perform the maintenance recommended by the manufacturer.

Neither inspection nor service is part of the equipment's warranty.

Maintenance performed must be documented and maintained with the equipment.

The table below gives a description of the main inspection items and recommended frequency.

Item	Inspection description	Recommended frequency
Safety system	Collision, Warning lights, and Interlock.	Daily
Electrical parts	Overheating/Noise/Burning smell	Monthly
Elevation	Operation/Noise/Vibration	Annual
Movement mechanism	Operation/Noise/Vibration	Annual
Foot controller and Controls	Operation/Damage	Annual







If problems are detected during the inspection, contact the Alliage Service Department.

### 7.2.PREVENTIVE MAINTENANCE

In addition to the annual inspection, to ensure a long service life and plain operation of your equipment, it is important to carry out preventive maintenance for a maximum period of three (3) years.

Contact the Alliage Service Department about our periodic overhaul and preventive maintenance program.

### 7.3.CORRECTIVE MAINTENANCE

	To repair or replace any part or part see instructions in the service manual.
	Corrective maintenance cannot be performed by the user. Do not open the equipment or try to repair it yourself or with the help of someone without training or authorization. This can aggravate the problem or produce a failure that can compromise the safety of the equipment.
	The power cables, electronic boards, fuses and belts can be changed only by the authorized technician. See service manual for connection and anchoring information.
	The equipment or any of its parts cannot be maintained or serviced during use with a patient.
	The equipment contains parts under high voltage. Risk of electric shock. Turn off the main switch before servicing.
	The service manual is only available for Authorized Technical Assistance.

Alliage declares that the provision of circuit diagrams, component lists or any other information that provides technical assistance on behalf of the user, can be requested as long as previously agreed between the user and Alliage.  
The warranty will be void if the original parts are removed/replaced by unauthorized service technicians.

### 7.4.ALLIAGE AUTHORIZED SERVICE NETWORK

All services performed on the Alliage equipment must be performed by an Authorized Technical Assistant, as otherwise they will not be covered by the warranty.

If you need to request electrical diagrams and or specification of components that is not stated in the user manual, use the Alliage Customer Service to make the request.

Phone: +55 (16) 3512-1212

Address: Rodovia Abrão Assed, Km 53 - Recreio Anhangüera - Ribeirão Preto-SP / Brazil -  
Zip Code 14097-500

# 8

## WARRANTY

### **8. WARRANTY**

This equipment is covered by the warranty periods, terms and conditions contained in the Warranty Certificate that comes with the product.

# 9

## STANDARDS AND REGULATIONS



### 9. STANDARDS AND REGULATIONS

This equipment has been designed and manufactured to meet the following standards:

ABNT NBR IEC 60601-1:2010 Amendment 1: 2016	Medical Electrical Equipment - Part 1: General basic safety requirements and essential performance.
ABNT NBR IEC 60601-1-2:2017	Medical Electrical Equipment, Part 1-2: General requirements for basic safety and essential performance - Collateral standard: Electromagnetic interference - Requirements and tests.
ABNT NBR IEC 80601-1-60:2015	General requirements for basic safety and essential performance of dental equipment
ABNT NBR 60601-1-6:2011	Electromedical equipment - Part 1-6: General requirements for basic safety and essential performance - Collateral standard: Usability;
ABNT NBR IEC 62366:2016	Health products - Application of usability engineering to health products;
IEC 60601-1-9:2014	Medical electrical equipment - Part 1-9: General requirements for basic safety and essential performance - Collateral standard: Requirements for environmentally conscious design
IEC 62304:2006	Medical device software - Software life-cycle processes.
ISO 9680:2014	Operating lights
ISO 7494-1:2018	Dentistry – Dental units – Part 1: General requirements and test methods
ISO 7494-2:2015	Dental units – Part 2: Air, water, suction and wastewater systems
ABNT NBR ISO 6875:2014	Dental patient chair
ISO 9687:2015	Graphical symbols for dental equipment
ISO 15223-1:2016	Graphic symbols for electrical equipment in medical practice
EN 1041:2008+A1 2013	Information provided by the medical device manufacturer.
ABNT NBR ISO 10993-1:2013	Biological assessment of medical devices - Part 1: Assessment and testing.
ABNT NBR ISO 14971:2009	Medical devices - Application of risk management to medical devices.
ABNT NBR ISO 13485:2016	Quality management systems - Requirements for regulatory purposes

# 10

## TECHNICAL SPECIFICATIONS

# 10. TECHNICAL SPECIFICATIONS

## 10.1.EQUIPMENT CLASSIFICATION

### Class of classification according to ANVISA

Class I

### Class of classification according to CE/FDA

Class I

### Equipment classification according to EN IEC 60601-1

Product classification for applied parts - Type B  
Protection Against Electric Shock - Class I

### Protection Against Harmful Water Penetration

IP00 - Product not protected against harmful penetration of water and particulate matter

### Degree of safety of application in the presence of a flammable anesthetic mixture with air or with oxygen or nitrous oxide

Unsuitable equipment

### Operating Mode

Non-continuous operation

#### Handpieces

Operating Time:

Ton: 1 min. / Toff: 4 min.

## 10.2.APPLIANCE INFORMATION (GENERAL)

### Supply mains voltage (from the chair)

12/24 V~

### Power supply frequency

50 / 60 Hz

### Allowable fluctuation

+/- 10 %

### Number of phases

Two-Phase

### Master switch

Single pole More than 100000 cycles 20A / 250 VAC

### Voltage inside the equipment (from the chair)

12/24 V~

### Unit net weight

39 kg

### Unit gross weight

45 kg

### 10.3.SPECIFIC INFORMATION

**Air pressure (from the chair)**

80 PSI (5.52 BAR)

**Air input pressure Syringe**

40 PSI (2.76 BAR)

**Maximum air consumption (from the chair)**

80 l/min

**Water tank capacity (from the water unit)**

1000 ml

**High speed air consumption**

32 L/min

**High speed water consumption**

42 ml/min

**Syringe air consumption**

17 L/min

**Syringe water consumption**

100 ml/min

**Venturi suction system - Maximum vacuum**

220 mm/Hg

**Venturi suction system - Volumetric displacement**

30 l/min

**Suction system "Vacuum Pump Bio Vac II" - Maximum vacuum**

400 mm/Hg

**Suction system "Vacuum Pump Bio Vac II" - Volumetric displacement**

120 l/min

**Suction system "Vacuum Pump Bio Vac IV" - Maximum vacuum**

550 mm/Hg

**Suction system "Bio Vac IV Vacuum Pump" - Volumetric displacement**

350 l/min

### 10.4.LED CURING LIGHT SPECIFICATION

**Power**

5.2 VA

**Light source**

1 LED

**Active medium**

Semiconductor LED (InGaN)

**Wavelength**

440nm – 460nm

**Timer**

60 seconds

### 10.5.INTRAORAL CAMERA SPECIFICATIONS

**Capture element**

1/4" Color CCD

**Power**

14VA

**Resolution**

480 TV line

**Focal Length**

2mm – 40mm

**Input/Output**

Digital 16bits

**Signal**

52Db

**Module power supply**

DC 5V

**Digital resolution**

8 Bit 256 Grad, 512x1024 pixels

**Lighting**

6 LEDs

**Weight**

89 g

## 10.6.INDUCTION CHARGER SPECIFICATIONS

### Power

10W

### Input

5V - 2A, 9V - 1.67A

### Output

5V - 1A, 9V - 1.1A

## 10.7.ENVIRONMENTAL CONDITIONS

### Environmental Conditions for Transportation and Storage

#### Transport or storage ambient temperature range

-12°C to + 50°C

#### Transport and storage relative humidity range

< 85% RH

#### Atmospheric pressure range

700 hPa to 1060 hPa  
(525 mmHg to 795 mmHg)

### Environmental installation and operating conditions

#### Ambient operating temperature range

+ 10°C to + 35°C

#### Operating relative humidity range (non-condensing)

< 75% RH

#### Atmospheric pressure range

700 hPa to 1060 hPa  
(525 mmHg to 795 mmHg)

#### Operating altitude

≤ 2000 m

10.8. UNIT DIMENSIONS

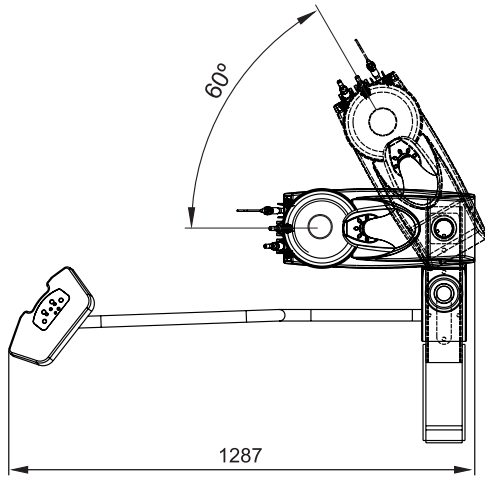
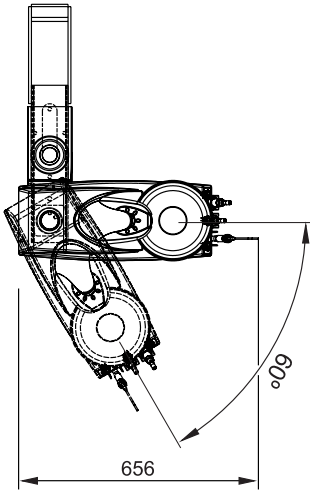
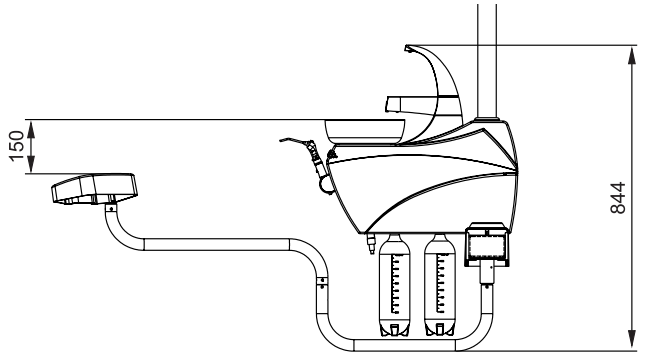
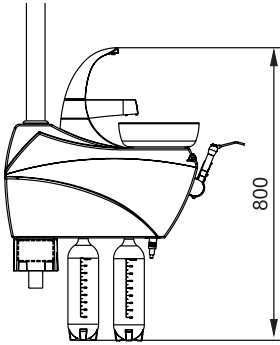

## ELECTROMAGNETIC COMPATIBILITY



## 11. ELECTROMAGNETIC COMPATIBILITY

The Dental Water Unit is intended for use in the electromagnetic environment specified below. The buyer or user should ensure that it is used in such an environment.

The Dental Water Unit is suitable for use in a professional healthcare environment, not including areas where there is sensitive equipment or sources of intense electromagnetic disturbances, such as the RF shielded room of a system for magnetic resonance imaging in operating rooms close to active AF surgical equipment, electrophysiology laboratories, armored rooms, or areas where short wave therapy equipment is used.

The following tables provide information on the equipment’s compliance with the ABNT NBR IEC 60601-1-2: 2017 standard.

### 11.1. ORIENTATION AND DECLARATION FOR ELECTROMAGNETIC EMISSIONS

Emission test	Compliance	Electromagnetic Environments - guidelines
RF emissions CISPR 11	Group 1	The Dental Water Unit uses RF energy only for its internal functions. Therefore, their RF emissions are very low and are not likely to cause any interference in nearby electronic equipment.
RF emissions CISPR 11	Class A	The Dental Water Unit is suitable for use in all establishments, except domestic ones and those directly connected to the public low-voltage power supply network that powers buildings used for domestic purposes.
Harmonic emissions IEC 61000-3-2	Class A	
Voltage fluctuations/flicker emissions IEC 61000-3-3	Complies	

**Note:** The emission characteristics of this equipment make it suitable for use in industrial areas and hospitals (IEC/CISPR 11, Class A). If used in a residential environment (for which IEC/CISPR 11, Class B is normally required), this equipment may not provide adequate protection for radio frequency communication services. The user might need to take mitigation measures, such as relocating or re-orienting the equipment.

## 11.2. ORIENTATION AND DECLARATION FOR ELECTROMAGNETIC IMMUNITY

Phenomenon	Basic EMC standard or test method	Immunity test level	Compliance level
Electrostatic discharge	IEC 61000-4-2	± 8 kV contact ± 2 kV, ± 4 kV, ± 8 kV, ± 15 kV air	± 8 kV contact ± 2 kV, ± 4 kV, ± 8 kV, ± 15 kV air
Irradiated RF EM fields	IEC 61000-4-3	3 V/m 80 MHz - 2.7 GHz 80 % AM at 1 kHz	3 V/m 80 MHz - 2.7 GHz 80 % AM at 1 kHz
Fields in proximity from RF wireless communications equipment	IEC 61000-4-3	See Table	See Table
Fast / saved electrical transients	IEC 61000-4-4 AC power input	± 2 kV 100 kHz repeat frequency	± 2 kV 100 kHz repeat frequency
	IEC 61000-4-4 signal input/output	± 1 kV 100 kHz repeat frequency	± 1 kV 100 kHz frequência de repetição
Line-to-line Outbreak	IEC 61000-4-5	± 0.5 kV, ± 1 kV	± 0.5 kV, ± 1 kV
Ground-Line Outbreak	IEC 61000-4-5	± 0.5 kV, ± 1 kV, ± 2 kV	± 0.5 kV, ± 1 kV, ± 2 kV
Conducted disturbances induced by RF fields	IEC 61000-4-6	3 V 0.15 MHz - 80 MHz 6V in ISM bands between 0.15 MHz and 80 MHz 80% AM at 1 kHz	3 V 0.15 MHz - 80 MHz 6V in ISM bands between 0.15 MHz and 80 MHz 80% AM at 1 kHz
Magnetic fields at declared power frequency	IEC 61000-4-8	30 A/m 50 Hz or 60 Hz	30 A/m 50 Hz or 60 Hz
Voltage dips	IEC 61000-4-11	0 % UT; 0.5 cycle At 0°, 45°, 90°, 135°, 180°, 225°, 270° and 315° 0 % UT; 1 cycle and 70 % UT; 25/30 cycles Single phase: at 0°	0 % UT; 0.5 cycle At 0°, 45°, 90°, 135°, 180°, 225°, 270° and 315° 0 % UT; 1 cycle and 70 % UT; 25/30 cycles Single phase: at 0°
Voltage interruptions	IEC 61000-4-11	0 % UT; 250/300 cycles	The device will turn off and/or reboot if power is interrupted for five seconds.

NOTE 1 At 80 MHz and 800MHz, the highest frequency range is applicable.

NOTE 2 These guidelines may not apply in all situations. Electromagnetic propagation is affected by absorption and reflection from structures, objects and people.

NOTE 3 UT is the voltage of the AC electrical network before the application of the test level.

## Proximity fields from wireless RF communications equipment

Test frequency (MHz)	Band (MHz)	Service	Modulation	Maximum Power (W)	Distance (m)	Immunity test level (V/m)
385	380-390	TETRA 400	Pulse modulation 18Hz	1.8	0.3	27
450	430-470	GMRS 460, FRS 460	FM deviation of $\pm 5$ kHz Sinoidal of 1kHz	2	0.3	28
710 745 7480	704-787	LTE Band 13, 17	Pulse modulation 217Hz	0.2	0.3	9
810 870 930	800-960	GSM 800/ 900, TETRA 800, iDEN 820, CDMA 850, LTE Band 5	Pulse modulation 18Hz	2	0.3	28
1720 1845 1970	1700 -1990	GSM 1800; CDMA 1900; GSM 1900; DECT; LTE band 1, 3, 4, 25; UMTS	Pulse modulation 217Hz	2	0.3	28
2450	2400-2570	Bluetooth, WLAN 802.11 b/g/n, RFID 2450, LTE Band 7	Pulse modulation 217Hz	2	0.3	28
5240 5500 5785	5100 - 5800	WLAN 802.11 a/n	Pulse modulation 217Hz	0.2	0.3	9

## List of used cables

Cables	Description	Width
Power Supply	Tripolar Power Cable Gauge 3x 2.50 mm <sup>2</sup> , 250V AC, Male Plug 20A NBR 14136 2P+T, no female plug, Inmetro. (From the chair)	3 m

	The Dental Water Unit is intended to assist health professionals, and it is for exclusive dental use. In case of EMC disturbances the operator may experience loss of communication between the equipment and controls.
	Compliance with EMC and EMI standards cannot be guaranteed by the use of altered cables or cables that do not meet the same standards as the equipment has been validated.
	The use of this equipment adjacent to other equipment should be avoided as this may result in improper operation. If this use is necessary, it is advisable that this and other equipment be observed to verify that they are operating normally.
	Do not use accessories, transducers, internal parts of components and other cables other than those previously specified by the manufacturer. This may result in increased emission or decreased electromagnetic immunity and result in improper operation.
	Portable RF communication equipment (including peripherals such as antenna cables and external antennas) should not be used within 30 cm of any part of the equipment, including cables specified by the manufacturer. Otherwise, performance degradation of this equipment may occur.
	To maintain basic safety against electromagnetic disturbances during the expected service life, always use the equipment in the specified electromagnetic environment and follow the maintenance recommendation described in this manual.
	Pins, connector sockets, or elements bearing the ESD warning symbol must not be touched or interconnected without ESD protection measures.









CINTERQUAL - Soluções de  
Comércio Internacional, Lda.  
Avenida Defensores de Chaves, Nº 4  
Escritório Idea Spaces  
1000-117 Lisboa, Portugal

NUM. REG. ANVISA: 10069210063

