

English

**OWNER'S
MANUAL**
SYNCRUS G3 H
DELIVERY UNIT

CE



PAGE INTENTIONALLY LEFT BLANK

PRESENTATION OF THIS MANUAL

Technical Name: Delivery Units and Accessories

Trade Name: Delivery Units

Models: Syncrus G3 H

Brand: Saevo

Technical Manager: Daniel R. de Camargo

CREA-SP: 5062199650

ANVISA Registration No.: 10069210075



Alliage S/A Industrias Médico Odontológica
Rodovia Abrão Assed, Km 53 + 450m - CEP 14097-500
Ribeirão Preto - SP - Brazil
Phone: +55 (16) 3512-1212



CINTERQUAL – Soluções de Comércio
Internacional, Lda.
Avenida Defensores de Chaves, Nº 4
Escritório Idea Spaces
1000-117 Lisboa, Portugal



77000000680 - Rev.: 04 - March/22

Document originally written in Portuguese.

TRADEMARKS

All terms mentioned in this manual that are known trademarks, registered trademarks or service marks have been appropriately labeled as such. Other products, services or terms that are mentioned in this manual may be trademarks, registered trademarks or service marks of their respective owners. Alliage S/A makes no claims regarding these trademarks. The use of a term in this manual should not be considered to influence the validity of any trademark, registered trademark or service mark.

Copyright © 2019 Alliage S/A. All rights reserved.

The performance characteristics provided in this manual are for reference only and should not be considered as guaranteed specifications.

TABLE OF CONTENTS

01	GENERAL INFORMATION	08
1.1.	DEAR CUSTOMER	08
1.2.	INDICATIONS FOR USE	08
1.3.	CONTRAINDICATION	08
1.4.	SYMBOLGY	08
02	WARNINGS, CAUTIONS AND RECOMMENDATIONS	14
03	SYSTEM GENERAL DESCRIPTION	19
3.1.	SYSTEM DESCRIPTION	19
3.2.	APPLICATION SPECIFICATION	19
3.2.1.	Operating principles	19
3.2.2.	Significant physical characteristics	19
3.2.3.	User Profile	19
3.3.	PRODUCT MAIN COMPONENTS	20
3.3.1.	Equipo	20
3.3.2.	Accessories	21
3.4.	PARTS APPLIED	24
3.5.	LABELS POSITIONING	24
3.6.	SYSTEM REQUIREMENTS	25
3.6.1.	Compressor requirements	25
3.6.2.	Vacuum pump requirements	25
3.6.3.	Installation location	27
3.6.4.	System layout	27
04	OPERATION	29
4.1.	INITIAL PREPARATION	29
4.2.	ELECTRIC MICROMOTOR ACTIVATION	38
05	CLEANING, DISINFECTION AND STERILIZATION	40
06	PROBLEMS DIAGNOSTICS	42
6.1.	TROUBLESHOOTING	42
07	INSPECTION AND MAINTENANCE	45
7.1.	PERIODIC INSPECTION	45
7.2.	PREVENTIVE MAINTENANCE	45
7.3.	CORRECTIVE MAINTENANCE	46
7.4.	ALLIAGE AUTHORIZED SERVICE NETWORK	47
08	WARRANTY	49
09	STANDARDS AND REGULATIONS	51
10	TECHNICAL SPECIFICATIONS	53
10.1.	EQUIPMENT CLASSIFICATION	53
10.2.	DEVICE INFORMATION	53
10.3.	SPECIFIC INFORMATION	54
10.4.	LED CURING LIGHT SPECIFICATION	54
10.5.	ULTRASOUND SPECIFICATIONS	55
10.6.	ENVIRONMENTAL CONDITIONS	55

TABLE OF CONTENTS

10.7. EQUIPMENT DIMENSIONS	56
11. ELECTROMAGNETIC COMPATIBILITY	58
11.1. ORIENTATION AND DECLARATION FOR ELECTROMAGNETIC EMISSIONS	58
11.2. ORIENTATION AND DECLARATION FOR ELECTROMAGNETIC IMMUNITY	59

GENERAL INFORMATION

1. GENERAL INFORMATION

1.1. DEAR CUSTOMER

Congratulations on your excellent choice. By purchasing equipment with ALLIAGE quality, you can be assured of acquiring products with a technology compatible with the best in the world in its class. This manual provides you with a general presentation of your equipment, describing important details that may guide you in your correct use, as well as in solving small problems that may occur. This manual should be read in full and kept for future reference.

1.2. INDICATIONS FOR USE

The Delivery Unit are intended to assist in the treatment and removal of caries, removal of restorations and odontosection, as an aid in the extraction of teeth, also indicated for burning mouth syndrome, dental abscesses, dental abrasion, among others linked to dental treatment.

1.3. CONTRAINDICATION

There is no known contraindication for this equipment.

1.4. SYMBOLOGY

The following symbols are used both throughout this manual and in the product. Make sure that you fully understand each symbol and follow the accompanying instructions.



Fragile, handle with care



Maximum stacking



Protect from rain

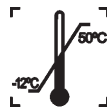

Temperature limit



This side up



Do not step



Keep away from sunlight



Recyclable



Movable Parts



Sterilizable in a steam sterilizer (autoclave) at specified temperature



Parts applied type B



It indicates that the product should be taken to a special garbage collection location at the end of its useful life. It applies to both the device and accessories



Attention



Electrostatic Sensitive Devices (ESD)



Protective ground



Action required



Follow the instructions for use



General warning



Warning;
High voltage



Do not reuse



Forward tilt



Bio-system activation



It descends the seat



It ascents the seat



It ascents the backrest



It descends the backrest



Back to zero



Determines work positions 1



Determines work positions 2



Determines work positions 3



Determines work positions 4



Massage zone



Arm fall



Ultrasound



Reflector activation



Bicarbonate jet



Inversion of the electric micromotor rotation direction



Ejector with controllable valve (Vac-plus)



Water activation in cup holder



Dental Turbine



Optical fiber



Motion stop



Syringe



Electric Motor



Negatoscope lamp



Spray cooling



Saliva suction controllable valve (Venturi)



Water activation in the bowl



Program 1



Program 2



Program 3



Plus key and Minus key



Forward/backward key



Authorized Representative in the European Community



It indicates that equipment complies with Directives 2011/65/EU and 2015/863/EU on the Restriction on the use of certain hazardous substances in electrical and electronic equipment.



Model



Manufacture Date



Catalog number



Model number



Serial number







Manufacturer

WARNINGS, CAUTIONS AND RECOMMENDATIONS

2. WARNINGS, CAUTIONS AND RECOMMENDATIONS

General warnings



	<p>Please read and understand all instructions contained in these instructions for use before installing or operating this equipment.</p>
	<p>Use only the equipment in perfect condition and protect yourself, patients and third parties from any hazards.</p>
	<p>This equipment must be installed and operated by personnel familiar with the necessary precautions.</p>
	<p>The Delivery Unit has 4 different interactions with the user, being:</p> <ul style="list-style-type: none">- Identification label: Located on the side of the equipment;- Safety symbologies: Located at the dangerous places and on their identification label; Central panel;- Side panel;

During transportation

The equipment must be transported and stored, observing the following:

- Handle care to avoid falls, excessive vibrations and impacts;
- The packing arrows should be pointing upwards;
- To handle the package as a single unit, consider the center of the gravity indicator;
- Do not stack above the quantity indicated on the package;
- Do not walk or stand on the package;
- Protect against sunlight, moisture, water and dust;
- Observe the temperature, pressure and relative humidity limits.

During the equipment installation

	<p>The installation instructions can be found in the service manual, accessible only to authorized technicians.</p>
	<p>The equipment must be installed only by the authorized technician. This is a technical procedure that cannot be performed by the user.</p>

- The equipment should only be installed by authorized technical assistants.
- The recommendations of the service manual should be followed as to the mandatory existence of protection grounding.
- Install the equipment in a place where it will not be in contact with moisture, water, plants and animals.
- Install the equipment in a location where it will not be damaged by pressure, temperature, humidity, direct sunlight, dust, airs or corrosive products.
- This equipment is not designed for use in the presence of vapors from flammable anesthetic mixtures or nitrous oxide.
- Place any other external devices at least 1.5 meters away from the equipment, so that the patient cannot touch any other external device while he/she is being serviced.
- The recommendations in this manual for EMC should be followed. Communications equipment and RF-generating sources can affect the operation of the equipment.
- The equipment may cause radio interference or interrupt the operation of nearby equipment, and it is necessary to take mitigating measures, such as reorientation, relocation of equipment or shielding the place.

Before using the equipment

To help ensure proper hygiene and protect against infectious diseases, prior to first use, the equipment should be cleaned and disinfected following the instructions contained in this manual.

When using the equipment

- Under no circumstances can the patient operate the equipment.
- The patient should not touch other parts other than those specific to be attended.
- The equipment should be operated only by qualified health professionals.
- While operating the equipment, the operating personnel must:
 - Read and understand the user manual.
 - Be familiar with the structure and fundamental functions of this equipment.
 - Be familiar with the emergency situation protocols of this equipment.
 - Be able to recognize irregularities in the operation of the equipment and implement the appropriate measures when necessary.
- The equipment is designed according to electromagnetic compatibility standards, but in very extreme conditions, it may interfere with other equipment. Do not use this equipment in conjunction with other devices that are very sensitive to interference or with devices that create high electromagnetic disturbances.

Owner's Manual

- Do not place the patient on the equipment while starting the equipment, as the patient may be injured if the equipment does not work properly. If there is an error that requires turning the equipment off and on, remove the patient before turning it back on.
- In case of risk to the patient, press the emergency button immediately located on the side of the equipment.
- If this product is exposed to water, moisture or foreign substances, turn it off immediately and contact an Alliage Authorized Service Center.
- In case of damage or defect, do not use the equipment and contact an Alliage Authorized Service Center.
- Do not use the equipment if any of its compartments or parts are damaged, loose, or removed. Contact an Alliage Authorized Service Center and request repair or replacement of any damaged, loose, or removed enclosures or parts of the equipment before using the equipment again.
- Do not touch the equipment or use it if it is being repaired or if the equipment cabinets have been removed.
- Do not open or remove any of the cabinets from the equipment. No internal part can be user-reparable.
- In case of fall or impact of moving parts causing the breakage of the same, be careful when handling them, there may be severe parts.
- This equipment does not produce physiological effects that are not obvious to the operator.
- The operator cannot contact the patient when in contact with accessible connectors.
- The operator cannot use tools to open the equipment.

Prevention against cross-contamination



Appropriate cleaning and disinfection/sterilization measures should be taken to avoid cross-contamination between patients, users and others.

- For each new patient, perform the procedures of cleaning, disinfection/sterilization and according to the instructions contained in this manual.

After using/operating the equipment

- Turn off the equipment if not in use for a long time.
- All parties that have had contact with the patient should be cleaned and disinfected/sterilized to each new patient to avoid transmission of infectious agents that may cause serious diseases.
- Clean and disinfect/sterilize as instructed in this manual.
- Do not unplug the cable or other connections without needing to.
- Do not modify any part of the equipment.

Precautions in case of change in the equipment operation

If the equipment has any abnormalities, check to see if the problem is related to an item listed in the "Problems Diagnostics" topic in this user manual.

If the problem cannot be resolved, turn off the equipment, contact an Alliage Authorized Service Center.

- The heater can only be changed by the authorized Alliage Service Provider.



The manufacturer is NOT responsible for:

- The equipment is used for purposes other than those for which it was designed.
- Damage caused to the equipment, operator and/or patient as a result of incorrect installation and maintenance procedures in disagreement with the operating instructions accompanying the equipment.

Precautions for reducing environmental impact

Alliage S/A aims to achieve an environmental policy to promote the supply of environmentally conscious medical and dental products that continuously minimize environmental impact and are more environmentally friendly to the environment and human health.

To maintain a minimal impact on the environment, please note the recommendations below:

- After installation, forward the recyclable materials to the recycling process.
- During the life cycle of the equipment, turn it off when it is not in use.
- To prevent environmental contamination, the disposal of waste and consumables should follow the normal procedure for biomedical waste.

Biomedical waste includes non-acute materials likely to cause disease or suspected of harboring pathogenic organisms that must be stored in a yellow bag properly labelled with a symbol of biological risk, stored in a puncture-resistant container, watertight, until collection and incineration.



The Equipment packaging consists of wood, cardboard, plastic and expanded polyurethane (PU) which are 100% recyclable materials.

DIMENSIONS:

Main unit: 1155 x 1070 x 470mm /MASS: Approximately: 30 Kg

Precautions in case of equipment being unused

To avoid environmental contamination or misuse of the equipment, when it is unused, it must be disposed of (according to current legislation) in an appropriate place, because the materials inside it can contaminate the environment.

For the European Economic Area (EEA), this product is subject to Directive 2012/19/EU as well as the corresponding national laws. This policy requires that the product should be taken to a special garbage collection location at the end of its useful life. It applies to both the device and accessories. Contact the dealer if the final disposal of the product is required.



This equipment should not be disposed of as household waste.

SYSTEM GENERAL DESCRIPTION

3. SYSTEM GENERAL DESCRIPTION

3.1. SYSTEM DESCRIPTION

Dental use equipment, for actuation and control of the syringe, rotary instruments and others, providing the best proximity to the operative field; ambidextrous (serves right and left-handed users). Set made of steel structure with ABS body injected with anti-UV protection. Flat paint high gloss epoxy-based, cured in an oven at 250° C, with phosphate treatment corrosion resistant and cleaning materials.

FLEX type pneumatic Model with stroke limiter stop. Attached to the chair, with wide horizontal and vertical movement, with pneumatic locking, powered by button located under the handle of the equipment, providing smoothness in movements and stop at the desired position.

Movement of tips through retractable rods with lock for relief in the tension of the hose (except from triple syringe Stem), which provides lightness of movements, allowing greater proximity to the operative field Automatic selection of tips through individual pneumatic valves, allowing lightness in your drive.

Flexible support for hand pieces is removable and autoclavable, protecting them against impact Smooth Hoses, rounded, light and flexible, without grooves or ridges.

Support for tray attached to the catheter with horizontal movements.

Bilateral handles.

3.2. APPLICATION SPECIFICATION

The Delivery Unit are an instrument support system integrated into the table such as syringe, hoses and tray.

3.2.1. Operating principles

The operation of Delivery Unit consists of a table that feeds and controls Delivery Unit and has movement through articulated arms with wide and pneumatic locking.

3.2.2. Significant physical characteristics

The Delivery Unit are constructed using a range of specific materials for each function, such as steel, cast iron and aluminum in its structure; polyurethane, PVC, steel and plastic in the finishing, etc.

3.2.3. User Profile

The Delivery Unit can be used by both sexes, with the minimum level of literacy with the ability to read and understand images, symbols, icons, Western characters (Arial font), numerical alpha characters, and may not present a degree of visual imperfection for reading or vision and average degree of impairment of recent memory, not being in clear capacity to perform the activities and functions of the product correctly the profession. The user needs to be a qualified health care professional and trained to perform the activities, functions frequently used in the application of Delivery Unit and their functions of primary operations.

3.3.PRODUCT MAIN COMPONENTS

3.3.1.Equipo

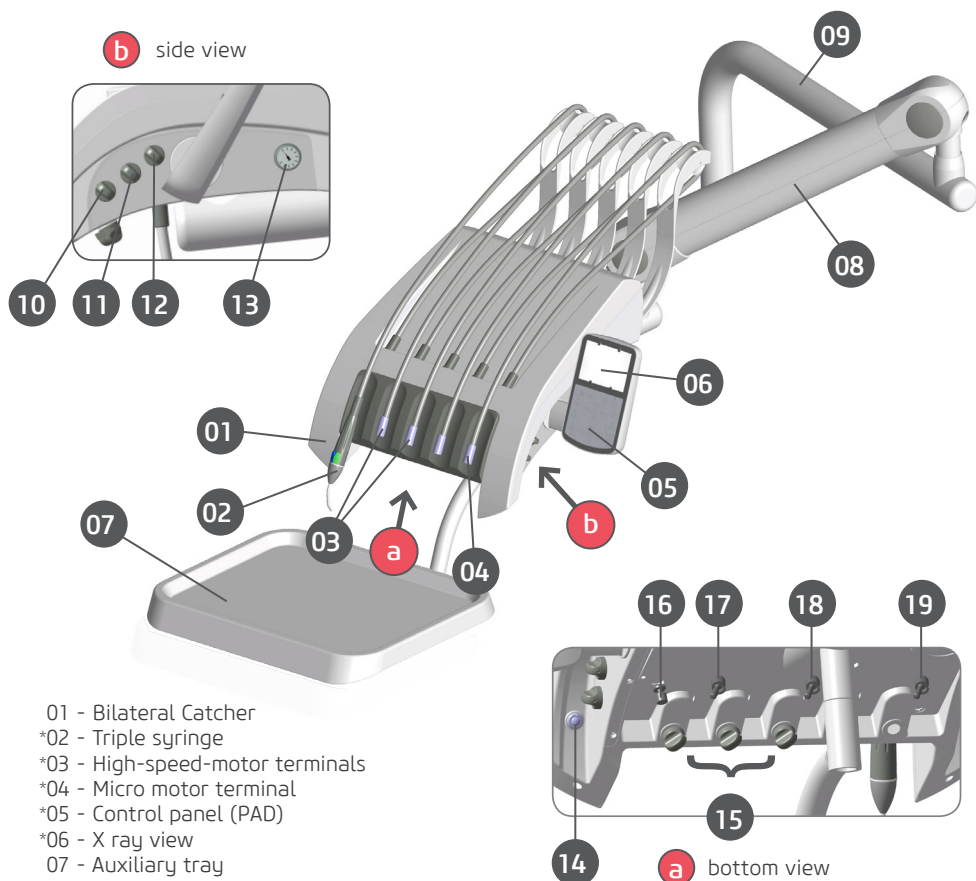

- 01 - Bilateral Catcher
- *02 - Triple syringe
- *03 - High-speed-motor terminals
- *04 - Micro motor terminal
- *05 - Control panel (PAD)
- *06 - X ray view
- 07 - Auxiliary tray
- 08 - Articulated arm
- 09 - Column arm
- *10 - Power (power ultrasound adjustment)
- *11 - Speed (electric microengine power adjustment)
- *12 - Light (electric microengine brightness adjustment)
- *13 - Manometer
- 14 - Arm brake valve
- *15 - Water records for FO/MME/Ultrasound/Bicarbonate Jet
- *16 - Bio-System operation
- *17 - MME rotation-wise reversal key
- *18 - LED reversal key (Ultra Vision)
- *19 - Heating water activation key in the syringe

* Optional items

3.3.2. Accessories

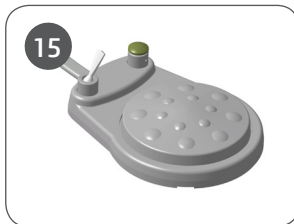
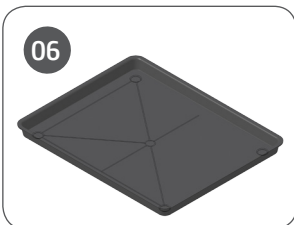
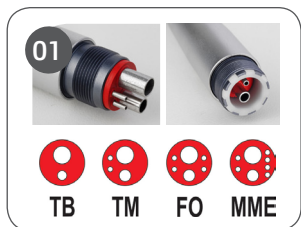



*01 - Terminals:

- Borden
- Midwest
- Fiber Optic
- Electric Micromotor

*02 - LED curing light

*03 - Control Panel Kit (PAD)

- Available in two versions (11 / 17 keys)

*04 - 3-way syringe with body fully injected in thermoplastic

*05 - 3-way syringe with fully metallic body or with handle injected in thermoplastic

*06 - Auxiliary tray / instrument holder

*07 - Stainless Steel Top

*08 - Bicarbonate jet kit (model with terminal and reservoir coupled to the Equipo)

*09 - Bicarbonate Jet Kit (Jet Hand model)

*10 - CART Coupling

*11 - Pneumatic FLEX Coupling

*12 - Mechanical FLEX Coupling

*13 - "Chip Blower" integrated foot controller

*14 - Progressive foot controller

*15 - Progressive foot controller with water activation/cut

*16 - 3-way syringe heater kit

*17 - Negatoscope Kit

*18 - Manometer

*19 - Ultrasound Kit

- Available in versions with fixed or detachable transducer with or without lighting

*20 - EMM Kit

*Optional Items (Subject to commercial availability)

The Equipos may be composed of:

Optional	Abbreviations
Terminal Borden	TB
Terminal Midwest	TM
Fiber Optic Terminal	FO
Electric Micromotor Terminal	EMM
LED curing light	OPTI
Control Panel	PAD
Bicarbonate Jet	JET
CART Coupling	C
Pneumatic FLEX Coupling	F
Mechanical FLEX Coupling	SF
Ultrasound	SONIC
Full Equipment	FULL ^o

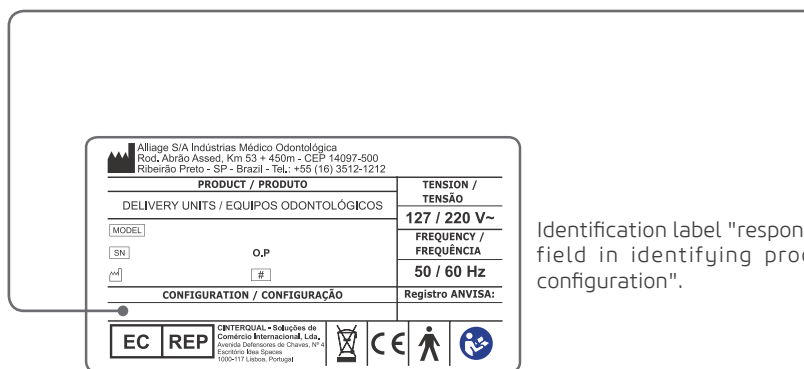

Identification label "responsible field in identifying product configuration".



Notes

Equipo Composition (setting)

Equipment with "FULL^o" nomenclature may contain some options together, such as: FO/EMM/OPTI/SONIC/PAD/JET, etc...

3.4. PARTS APPLIED

The following item is used in the patient treatment.

Type of parts		Type of contact	Contact duration	Classification
Pneumatic handpieces	Detachable	Mucous membrane	1 min	N/A
Ultrasound	Fixed	Mucous membrane	1 min	Type B
Electric Micromotor	Detachable and fixed	Mucous membrane	1 min	Type B
LED curing light	Detachable and fixed	Mucous membrane	1 min	Type B
Syringe nozzle	Detachable	Mucous membrane	1 min	N/A

* Not supplied with the product.

3.5. LABELS POSITIONING

The following figure illustrates the labels location on the equipment.



Illustrative image

Abilage S/A Industrias Médico Odontológica Rod. Abílio Assedi, Km 53 + 450m - CEP 14087-500 Ribeirão Preto - SP - Brazil - Tel.: +55 (16) 3512-1212		TENSION / TENSÃO	
PRODUCT / PRODUTO DELIVERY UNITS / EQUIPOS ODONTOLÓGICOS		127 / 220 V~	
MODEL SN #	O.P. #	FREQUENCY / FREQUÊNCIA 50 / 60 Hz	
CONFIGURATION / CONFIGURAÇÃO		Registro ANVISA:	
EC REP	CENTRIGUAL - Schottel de Comércio Internacional Ltda. Avenida Orlândia de Moraes, 51-1 Excursion 300 Spacia 05037-000 São Paulo		



3.6.SYSTEM REQUIREMENTS

3.6.1.Compressor requirements

The compressor is required to provide compressed air for clinical and laboratory use, having stable performance and flow capacity according to the minimum requirements required for the installation of the dental chair, besides being free of oil or emission of fumes, vapors or unpleasant odors.

It must have a valve safety system that comes into operation for pressure release in the event of a pressure failure and also an overload protector for the purpose of protecting the equipment from overheating. The location of its installation should be an airy place, preferably outside the office and should not be installed in sanitary facilities such as bathrooms and toilets, to minimize contamination of the air used in the dental chairs.

For patient, operator safety and the perfect operation of the product, the compressor installation must comply with the following recommendations:

Install a pressure relief device with the compressor;

Install air filter with pressure regulator, thus preventing oil, moisture and solid particles from penetrating inside the dental chair and then reaching its vital parts, for example; valves, handpieces, etc.;

Install the compressor near the power point to avoid losses;

In the installations preferably use rigid copper pipes. Pipes can also be executed with galvanized steel tubes, stainless steel, nylon or polyethylene.

Pressure limit of 80 psi; Limit flow rate ≥ 47 NL/min;

Humidity limit between 40% and 60%;

Oil contamination limit of 0.5 mg/m³;

Particle contamination limit of < 100 particles/m³ (particles of size between 1 and 5 μ m);

Air quality regulations comply with the laws of each country.

3.6.2.Vacuum pump requirements

The Vacuum Pump is required to have high suction power, to allow the professional a better visualization of the operative field with reduced risk of aerosol contamination and greater comfort to the patient, avoiding its constant displacement to the water unit during the clinical procedure. The proper functioning of the Vacuum Pump is indispensable to ensure infection control in the dental chair and asepsis of the patient's oral cavity, as it vacuum and drains the residuals from the mouth out of the dental chair. Larger parts of the solids should be retained in a debris separator, from which they should be removed daily.

The Vacuum Pump must be installed in a place where it will not be damaged by pressure, temperature, humidity, direct sunlight, dust or salts. The equipment should not be subjected to tilting, excessive vibration, or shock (including during transport and handling).

The suction power must be regulated by a stopcock according to the dental chair need and the motor must have a thermal protector, which turns off the equipment in case of overheating and prevents the motor from burning.

The Vacuum Pump must have a minimum vacuum pressure of 75 mmHg so that the ejectors have a sufficient suction power for mouth cavity aspiration and the value for the maximum vacuum pressure should be 500 mmHg per dental chair installed.

To considerably increase the service life of its components, the materials used in manufacturing must be highly resistant to corrosion.

For patient, operator safety and the perfect operation of the product, the installation of the Vacuum Pump must comply with the following recommendations:

The equipment is not designed for use in environments where vapors, flammable anesthetic mixtures with air, or oxygen and nitrous oxide can be detected;

The equipment must be grounded correctly;

Although this equipment has been designed according to electromagnetic compatibility standards, it can, in very extreme conditions, cause interference with other equipment. Do not use this equipment in conjunction with other devices that are very sensitive to interference or with devices that create high electromagnetic disturbances;

Do not submit to plastic parts for contact with chemical substances used in dental treatment routines.

Such as: acids, mercury, acrylic liquids, amalgams, etc.;

Avoid pouring water or other liquids into the equipment, which could cause short circuits; Before starting the operation of the Vacuum Pump, make sure that the voltage input cable plug is plugged into the mains, and that the water supply stopcock is open;

The lack of water will result in damage to the mechanical seal and the Vacuum Pump will not vacuum;

Never use detergent or any sparkling product to clean the vacuum pump suction tubes internally;

Do not modify any part of the equipment. Do not unplug the cable or other connections without need;

Before cleaning the equipment, turn off the master switch;

Do not use micro abrasive material or steel straw in cleaning, do not use organic solvents or detergents containing solvents such as ether, stain strip, etc.;

To avoid the risk of infection, wear protective gloves when handling filters and drains. Dispose of contaminated waste and products in biological waste;

Never use sparkling products in suction (Descaling, Detergents, Flotators, etc.), this procedure may damage the internal parts of the Vacuum Pump motor;

Never use the bleach solution for external cleaning of the Vacuum Pump and/or any equipment, as this mixture is highly corrosive and may damage metal parts.

3.6.3. Installation location



To meet safety standards, do not operate non-medical equipment, such as personal computers, within the patient area. Outside the patient's area, the presence of non-medical equipment is acceptable, provided that approved and certified computer equipment is used.

Computer equipment must be EC approved and must comply with EC 60950-1:2005 + AMD1:2009 + AMD2:2013 and low voltage and 2014/EU low voltage and 2014/30/EU guidelines 2014/EU

3.6.4. System layout



* Do not accompany the product

4

OPERATION

4. OPERATION

4.1. INITIAL PREPARATION



The equipment should be cleaned and disinfected prior to use in a new patient, observing the instructions contained in this manual.



To insulation the power supply equipment, use the master switch.

Turning on/off the dental chair

Turn on the master switch to the Chair. All equipment function will be enabled. The master switch has an internal LED that is lit when the chair is turned on.

Positioning

The arm has horizontal and vertical movements, with a pneumatic locking device. Maintaining the button "Arm break valve" pressed, place the delivery unit in the desired position holding it by the handle, and release it to fasten it in this position.

Retractable rods with lock

Pull the rod smoothly until the lock is activated automatically.

In order to withdraw the rod, pull it again until the lock is released.

Note: The syringe rod does not have a lock.

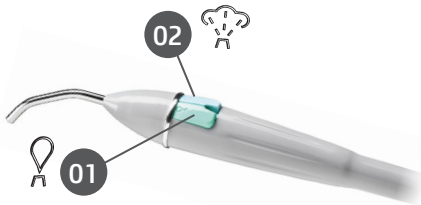
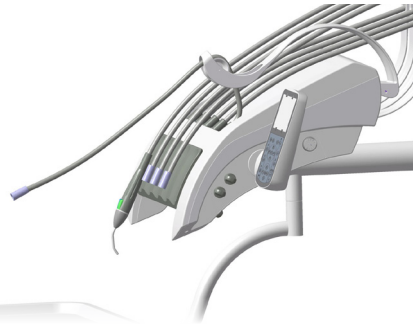

3-way syringe Use

Press the button (01) to get out water, (02) to get out air or both simultaneously to get spray.

Water heating activation*

When you turn on the key switch, you will turn on the Led indicating the start of the syringe water heating. The temperature should remain between 40°C. To turn off the heating function, position the switch again.

* Optional items

Spray adjustment on "high and low rotation TB/TM terminals"

The adjustment is done through a stopcock positioned in the terminal. Rotate it to decrease or increase the spray.

Note: Since it does not have spray, the "TB" double terminal does not need adjustment



Spray adjustment on "high and low rotation FO/EMM terminals"

The adjustment is made through the stopcocks positioned below the equipo box (a). Rotate it to decrease or increase the spray.



a Water stopcocks

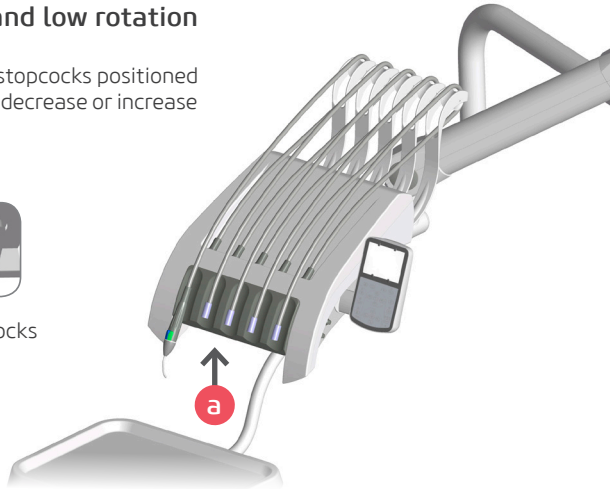

High-speed terminals with dual "LED selection" lighting system*

Select the desired lighting system via the inversion switch.



LED lighting with white light.

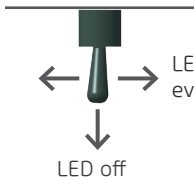

LED lighting with material evidencer (Ultra Vision).

LED off

* Optional items

Terminals activation

Progressive foot controller* (fig.1)

For operate rotating instruments, remove the instrument to be used from the stand, activate the control foot controller (b).

Progressive foot controller with chip-blower function/ handpiece water lock system* (fig.2)

For operate rotating instruments, remove the instrument to be used from the stand, activate the control foot controller (b).

To trigger the handpiece water lock system, place the switch (d) in Off to unlock. Return to the starting position to lock. Pressing the (e) down key will trigger air on the tips.

Foot controller chip-blower* (fig.3)

For operate rotating instruments, remove the instrument to be used from the stand, activate the control foot controller (b).

 The power (air supply) can be controlled by the operator with greater or lesser pressure on the foot controller lever (a).

The "chip-blower" system allows the release of airflow with the turbine down (air function).

Pressing the (e) down key will trigger air on the tips. Pressing the (e) down key and shifting the lever (a) to the right together will trigger the high-speed air and water turbine (spray).

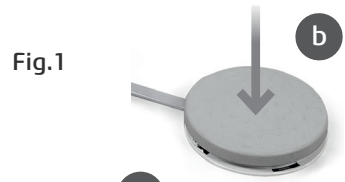

Fig.1

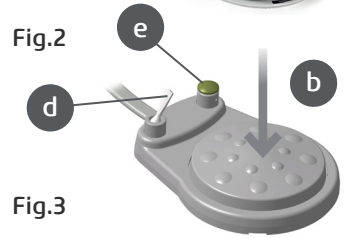
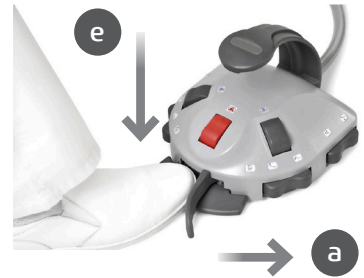
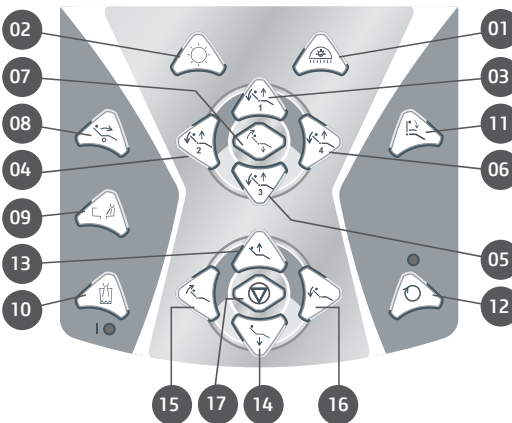

Fig.2

Fig.3



Activation via control panel kit (PAD)



- 01 - Reflector activation
- 02 - Negatoscope activation
- 03 - Determines the working position 1
- 04 - Determines the working position 2
- 05 - Determines the working position 3
- 06 - Determines the working position 4**
- 07 - Determines the back to zero position
- 08 - Return to the last position/Spitting Position**
- 09 - Water Activation in the Bowl**
- 10 - Water Activation in the cup holder**
- 11 - Arm fall**
- 12 - EMM rotation direction inversion**
- 13 - Seat ascent
- 14 - Seat descent
- 15 - Backrest ascent
- 16 - Backrest descent
- 17 - Emergency stop**

** Functions available for PAD control panel 17 keys.

* Optional items

Reflector activation

Press and release the key (01) to turn the Reflector on or off.

To switch the light intensity of the Reflector, hold down the key until the Reflector reaches the desired intensity.

Work positions

The Equipo panel has programmable working positions. To program, simply place the chair in position and reflector at the desired intensity and keep the key of the chosen working position pressed for 3 seconds, the chair will emit a long beep determining that the position has already been programmed.

Automatic movement to position back to zero - V0

Press the key (07) so that the seat and backrest simultaneously return to zero. This is the most comfortable position for the patient to get in/out the Chair.

To stop the movement, activate the foot controller in any direction or quickly press the key (07). The reflector will automatically turn off after pressing the key (07).

Returns to the last position "Spitting Position**"

When you press the "Return to the last "Spitting Position" button (08), the reflector will turn off (if it is on), start the water flow in the bowl (until the set time or if you have not programmed for 30 seconds) and the backrest will fully rise to the Spit Position, when you turn it back on, the backrest will return to the previous position and the reflector will turn on.

Emergency stop**

When you press the "Emergency Stop" button (17), the Emergency Led will light up and an automatic stop of all movements of the chair will occur, being locked until the "Emergency Stop" button is pressed again (17). This operation does not cancel the positions and schedules already recorded. We recommend using it during long surgical procedures, as the chair will be blocked, preventing unexpected movements.

Programming water in cup holder/bowl**

To program the water flow time in the cup holder (10)/bowl (09), hold down the corresponding key, 3 short beeps will be emitted indicating the programming mode.

Release the key after the desired time interval. The flow time is recorded.

The maximum programming time is 60 seconds, exceeding this limit an error beep will be emitted indicating that the time has not been scheduled.

Concealable arm activation**

To release the fall of the arm, press the key (11).

How to supply the reservoirs (syringe water / tips)

Remove the reservoir by unscrewing it and make the water reset. After restarting, replace it.

Always use filtered water or aseptic products.

** Functions available for PAD control panel 17 keys.

Bio-System*

Remove the reservoir by unscrewing it and make the replacement. Use chlorinated water solution 1:500. The preparation of the solution is done as follows: from a solution of 1% sodium hypochlorite a solution is prepared a solution of chlorine at 500 p.p.m.

How to prepare the solution: use 25 ml of 1% sodium hypochlorite solution and dilute in 500 ml of water (1 to 20). This solution should be prepared daily.



Warning

- Strictly follow this ratio to avoid equipment damage and an efficient disinfection result.

Bio-System Activation*

Remove the handpieces from the terminals. Take the handpiece terminals to the sink or bowl of the water unit.

Fully open terminals spray stopcocks. Activate the Bio-System activation key for a few seconds to internally disinfect the components of the Equipo with bactericidal liquid.

Then, press the foot control for a few seconds to rinse, to eliminate the chemical residues of the bactericidal liquid retained internally in the components of the Equipo.



Warning

- This procedure must be done at the beginning of the day and after each patient.

LED curing light*



a



a - Before using, please sterilize the light conductor, disinfect the handpiece and the cable.

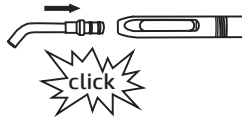

b

b - Insert the light conductor into the handpiece until you hear a slight click and feel that it has fitted correctly.

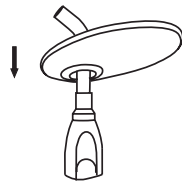

c

c - Insert the eye protector into the light conductor.



Attention

Always keep the light conductor protected by disposable PVC film that must be changed for each patient. This procedure protects the light conductor against scratches and the accumulation of undesirable residues.

* Optional items

- Press the button to turn on the equipment (01)
- Select the application mode by pressing the selection button (02), the variations of which are:
 - **Continuous:** Maximum and continuous light intensity mode (same luminosity from the beginning to the end of the polymerization).
 - **Ramp:** Gradually light intensity increases gradually.
 - **Pulsed:** Pulsed mode are cycles that oscillate at a fixed frequency.
- The chosen application mode will be shown on the display.
- To program the time, press the button (03) and choose the time from 5 to 20 seconds, which will be shown on the display (04).

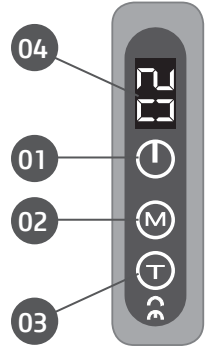

Use the polymerization time recommended by the composite resin manufacturer and always perform restorations in incremental layers with a maximum thickness of 2mm.

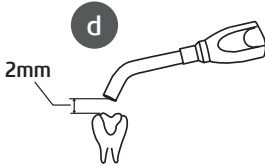

d - After selecting the application mode and choosing the time, remove the protective cover from the light conductor, bring the handpiece to the patient's mouth and position the light conductor at a safe distance.

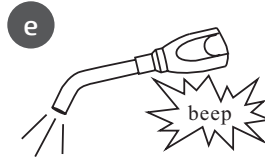

e - To start the polymerization cycle, press the trigger button. To interrupt, just press again.

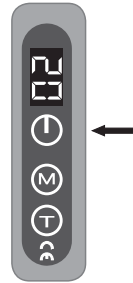

Warnings

- Never direct the beam of blue light at your eyes;
- Protect the visual field using the Eye Protector;
- The Eye Protector has the objective of filtering only the blue light that acts in the photopolymerization of resins to protect the vision and still allows the ambient lighting to pass into the operative field.



Auto shutdown:

The equipment will automatically turn off when not in use for more than 3 minutes. To turn it back on, press the power button.

Use of the bicarbonate jet *

The bicarbonate jet removes dark stains from the teeth, caused by cigarettes, coffee, tea, etc., associated with bacterial plaques and not with calculus.

To obtain the best result from the bicarbonate jet, we recommend respecting the distance of the handpiece in relation to the tooth (5mm), with an inclination of 30° to 45° describing small circular movements on the teeth.

To avoid unpleasant sensations in patients, the jet of bicarbonate should be directed to the occlusal edge and not to the gingival sulcus.

* Optional items



Warning

- This equipment is contraindicated for use in patients who have serious respiratory or renal disorders or who are undergoing hemodialysis, these cases must have medical monitoring. We recommend the use of a mask and glasses for the application of the bicarbonate jet.

Remove the top cap (a) by unscrewing it and add enough sodium bicarbonate for a section of prophylaxis, that is, 20 to 40g (do not exceed the level indicated on the container). The bicarbonate level is visible through the transparent container (e). To remove the leftover bicarbonate powder, unscrew the container (e) and clean it.



Warning

- Do not add more than 40g of bicarbonate to the container, as this may cause clogging of the powder outlet. The level of bicarbonate is visible through the transparent container.

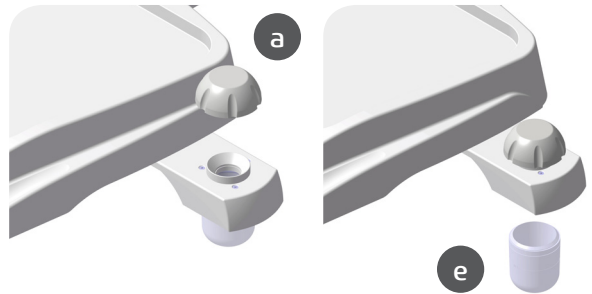

The volume of water and air flow can be regulated according to the need, as follows:

Direct the handpiece of the bicarbonate jet to a container (01) (Ex: spittoon, sink bowl, etc.).

Activate the foot control (02) and proceed with the water volume adjustments "through the corresponding stopcock (a)". The amount of water in excess will decrease the effect of the powder due to washing. Decreasing the water too much will cause the powder to become more aggressive.



Warning

The effectiveness depends on the perfect dosage of the water volume and the amount of powder.

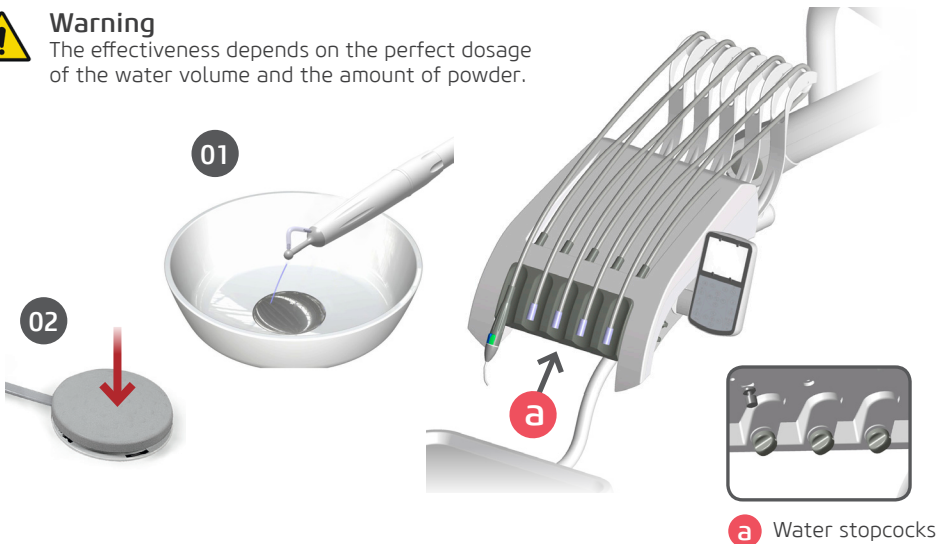

* Optional items

Ultrasound activation*

Remove the ultrasound handpiece from the holder;
Choose the appropriate insert for the desired operation according to "Techniques and Applications";
Screw the chosen insert onto the handpiece with the help of the fixation wrench (01) and a small tightening;

Activate the progressive foot controller (02).

Position the power selector (b) according to the sensitivity of the operation.

Regulate the water flow through the corresponding stopcock (a).

At the end of the procedure, release the foot controller (02) and place the handpiece on the holder.



Function available on the side panel when the equipo presents ultrasound in its configuration.



Warning

- Do not leave the handpiece with an insert in the tip holder to avoid accidents.

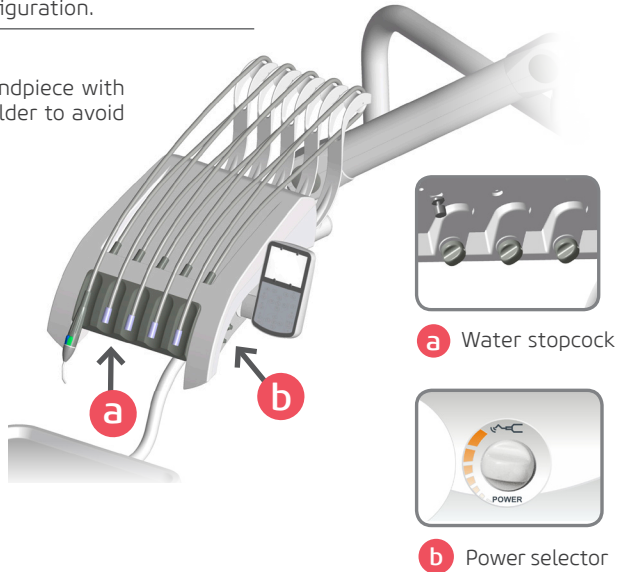

Note (important recommendation)

The shape and weight of each insert are determining factors to obtain maximum performance from the ultrasound generator, the operator's attention to these two characteristics, will ensure the maintenance of the best performance of the unit, however, we recommend that the structure of the insert is not altered (by filing or twisting it), in the same way the aging of an insert leads to a change of its original characteristic, making it ineffective.

Any insert that has been damaged by use or accidental impact must be replaced.

* Optional items

Techniques and applications

All ultrasound inserts have the particularity of vibrating in a single plane (vibrations from front to back, and on the axis of the insert).

The lateral vibrations common to other scalars do not exist, the straight displacement favors a more precise approximation of the tooth and gum.

Enamel and cement are protected from unnecessary shock. Within this main plane of vibration, the end of each insert is driven by small vibratory movements.

To obtain the maximum performance of the ultrasound, the operator must consider the vibration settings specific to each insert.

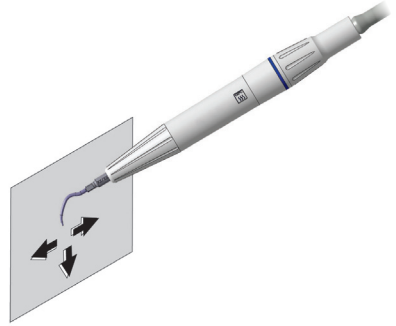

Periodontic

Better angle and longer length

Tips indicated for the removal of dental calculus on all surfaces of the supra and sub gingival teeth.



Perio E*



Perio Sub



Perio Supra

Endodontics

Tips for removing fractured instruments, removing intra-root pins, cements, etc.



Remo N*



Remo C*



Endo G*



Endo L*

* Optional items
(Subject to commercial availability)

4.2.ELECTRIC MICROMOTOR ACTIVATION

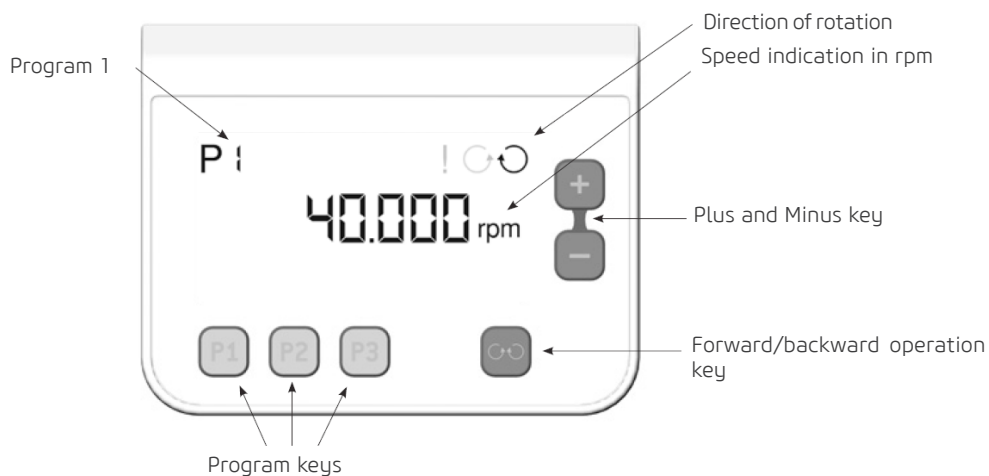

To start the micromotor, position the equipo rod forward (a), where the terminal for the electric micromotor is attached and choose the rotation speed:

RPM	%
40,000	100
30,000	75
20,000	50
10,000	25
4,000	10
2,000	5



ON
Micromotor rod displaced forward

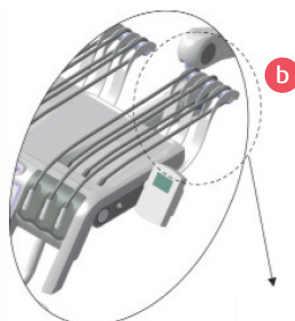

OFF
Micromotor rod in initial position

5

CLEANING, DISINFECTION AND STERILIZATION

5. CLEANING, DISINFECTION AND STERILIZATION



Before starting the cleaning and disinfection procedure, turn off the equipment main switch to avoid permanent damage.



For your protection, during the process of cleaning and disinfecting the equipment, use PPE such as disposable gloves and goggles.

The cleaning and disinfection process must be performed at each patient change. When starting the process, check for visible dirt, such as blood or saliva. Carefully clean the patient's entire contact area, such as upholstery lining. For cleaning use a clean, soft cloth moistened with mild soap and then dry with a clean, soft cloth or paper towel. For the disinfection process of the equipment, use disinfectant detergent foam that has active components based on didecylidimethylammonium chloride. Apply the disinfectant detergent foam on the surface or on a clean cloth and spread it over the surface to be treated. Respect the antimicrobial contact time specified by the manufacturer. After application, allow to dry. Do not rinse off. Some of the removable parts that come in contact with the patient can be autoclaved. These parts are: Syringe nozzle, ultrasound cover, LED curing light tip, contra-angle, straight piece, high rotation, Tips.



All accessories suitable for sterilization must be sterilized only in an autoclave at 135 °C with at least 3 minutes of waiting time and with a pressure of 2.2 bar.

If these items are autoclaved, disinfection by alternative methods is not necessary. There is no limit on cycles or application time that the equipment and its parts can tolerate during the cleaning, disinfection and/or sterilization process, following the instructions in this manual.



Do not spill liquid disinfectant on the equipment.



Do not use organic solvents, for example, thinner, to clean the equipment. In the event that the developer solution is spilled on the panel, clean it immediately, as these solutions may compromise the equipment's paint.



Sterilization parameters must always be followed. Accessories that are not properly sterilized can cause disease in patients.

6

PROBLEMS DIAGNOSTICS

6. PROBLEMS DIAGNOSTICS

6.1.TROUBLESHOOTING

In case you encounter any problem in the operation, follow the instructions below to check and fix the problem, and/or contact your representative.

Unforeseen incident	Probable Cause	Solutions
- Handpiece does not work.	- Compressor off.	- Start the compressor.
- Handpiece with low rotation.	- Dental chair supply pressure below specified (80 PSI).	- Adjust the supply pressure (80 PSI).
- There is no water in the handpieces spray.	- Air deficiency in the compressor. -Lack of water in the reservoir. -Handpiece coupling terminal closed.	- Regularize air supply. - Fill the reservoir with filtered water. - Open the terminal.
- There is no water in the syringe.	-Lack of water in the reservoir. -Compressor off.	- Fill the reservoir with filtered water. - Start the compressor.
- When activating the Bio-System, no bactericidal liquid comes out of the handpiece terminals.	-Lack of liquid in the Bio-System reservoir. -Chair fuse blown. -Chair master switch off.	- Fill the reservoir with bactericidal liquid. - Turn off the power to the chair and request the presence of a Technician. - Turn on the Chairs main switch.
- Negatoscope viewer does not work.	- Chair fuse blown. -Chair master switch off.	- Turn off the power to the chair and request the presence of a Technician. - Turn on the Chairs main switch.
- LED curing light completely inoperative.	- Lack of electricity. - Chair fuse blown.	- Check the electrical network. - Turn off the power to the chair and request the presence of a Technician.
- The equipment is not polymerizing the resins.	- Resin not suitable for the wavelength range of LED curing lights.	- Acquire resin suitable for the LED curing light wavelength, that is, it contains photoinitiators with camphorquinone.
- The ultrasound does not work.	- Blown fuse.	- Turn off the power to the chair and request the presence of a Technician.

Unforeseen incident	Probable Cause	Solutions
<ul style="list-style-type: none">- Lack of power in the ultrasound.	<ul style="list-style-type: none">- Deformed insert.- Loose insert.- Misuse (incorrect attack angle).	<ul style="list-style-type: none">- Replace the insert.- Tighten the insert with the wrench.- See item "Techniques and applications".
<ul style="list-style-type: none">- There is no water in the handpieces.	<ul style="list-style-type: none">- Inadequate water supply pressure.- Poor regulation of the water flow.	<ul style="list-style-type: none">- Correct the water pressure.- Adjust the water flow through the Ultrasound water register.

If problems persist, contact the Alliage Service Department.

7

INSPECTION AND MAINTENANCE

7. INSPECTION AND MAINTENANCE



Maintenance or service procedures may only be carried out by a technical service authorized by the manufacturer.

All instructions for using the equipment as intended are provided in this user guide. If a problem is detected and cannot be corrected with the instructions in the problem diagnostics section, contact the Alliage Service Department.

7.1.PERIODIC INSPECTION

It is imperative that this equipment be inspected regularly to ensure operational safety and functional reliability. This inspection must be carried out by personnel familiar with the necessary precautions to avoid exposing the patient to risk.

Periodic inspection should be carried out at regular intervals (at least once a year) to ensure that the product is permanently safe and operational. All components subject to normal wear and tear should be checked and, if necessary, replaced.

The manufacturer and the assembler/installer are exempt from responsibility for the standard results not being compliant in cases where the user does not perform the maintenance recommended by the manufacturer.

Neither inspection nor service is part of the equipment's warranty.

Maintenance performed must be documented and maintained with the equipment.

The table below gives a description of the main inspection items and recommended frequency.

Item	Inspection description	Recommended frequency
Safety system	Collision, Warning lights, and Interlock.	Daily
Electrical parts	Overheating/Noise/Burning smell	Monthly
Elevation	Operation/Noise/Vibration	Annual
Movement mechanism	Operation/Noise/Vibration	Annual
Foot controller and Controls	Operation/Damage	Annual







If problems are detected during the inspection, contact the Alliage Service Department.

7.2.PREVENTIVE MAINTENANCE

In addition to the annual inspection, to ensure a long service life and plain operation of your equipment, it is important to carry out preventive maintenance for a maximum period of three (3) years.

Contact the Alliage Service Department about our periodic overhaul and preventive maintenance program.

7.3.CORRECTIVE MAINTENANCE

	To repair or replace any part or part see instructions in the service manual.
	Corrective maintenance cannot be performed by the user. Do not open the equipment or try to repair it yourself or with the help of someone without training or authorization. This can aggravate the problem or produce a failure that can compromise the safety of the equipment.
	The power cables, electronic boards, fuses and belts can be changed only by the authorized technician. See service manual for connection and anchoring information.
	The equipment or any of its parts cannot be maintained or serviced during use with a patient.
	The equipment contains parts under high voltage. Risk of electric shock. Turn off the main switch before servicing.
	Moving parts can cut or crush.
	The service manual is only available for Authorized Technical Assistance.

Alliage declares that the provision of circuit diagrams, component lists or any other information that provides technical assistance on behalf of the user, can be requested as long as previously agreed between the user and Alliage.
The warranty will be void if the original parts are removed/replaced by unauthorized service technicians.

7.4.ALLIAGE AUTHORIZED SERVICE NETWORK

All services performed on the Alliage equipment must be performed by an Authorized Technical Assistant, as otherwise they will not be covered by the warranty.

If you need to request electrical diagrams and or specification of components that is not stated in the user manual, use the Alliage Customer Service to make the request.

Phone: +55 (16) 3512-1212

Address: Rodovia Abrão Assed, Km 53 - Recreio Anhangüera - Ribeirão Preto-SP / Brazil -
Zip Co 14097-500

8

WARRANTY

8. WARRANTY

This equipment is covered by the warranty periods, terms and conditions contained in the Warranty Certificate that comes with the product.

9

STANDARDS AND REGULATIONS

9. STANDARDS AND REGULATIONS

This equipment has been designed and manufactured to meet the following standards:

ABNT NBR IEC 60601-1:2010 Amendment 1: 2016	Medical Electrical Equipment - Part 1: General basic safety requirements and essential performance.
ABNT NBR IEC 60601-1-2:2017	Medical Electrical Equipment, Part 1-2: General requirements for basic safety and essential performance - Collateral standard: Electromagnetic interference - Requirements and tests.
ABNT NBR IEC 80601-1-60:2015	General requirements for basic safety and essential performance of dental equipment
ABNT NBR 60601-1-6:2011	Electromedical equipment - Part 1-6: General requirements for basic safety and essential performance - Collateral standard: Usability;
ABNT NBR IEC 62366:2016	Health products - Application of usability engineering to health products;
IEC 60601-1-9:2014	Medical electrical equipment - Part 1-9: General requirements for basic safety and essential performance - Collateral standard: Requirements for environmentally conscious design
IEC 62304:2006	Medical device software - Software life-cycle processes.
ISO 9680:2014	Operating lights
ISO 7494-1:2018	Dentistry – Dental units – Part 1: General requirements and test methods
ISO 7494-2:2015	Dental units – Part 2: Air, water, suction and wastewater systems
ABNT NBR ISO 6875:2014	Dental patient chair
ISO 9687:2015	Graphical symbols for dental equipment
ISO 15223-1:2016	Graphic symbols for electrical equipment in medical practice
EN 1041:2008+A1 2013	Information provided by the medical device manufacturer.
ABNT NBR ISO 10993-1:2013	Biological assessment of medical devices - Part 1: Assessment and testing.
ABNT NBR ISO 14971:2009	Medical devices - Application of risk management to medical devices.
ABNT NBR ISO 13485:2016	Quality management systems - Requirements for regulatory purposes

10

TECHNICAL SPECIFICATIONS

10. TECHNICAL SPECIFICATIONS

10.1. EQUIPMENT CLASSIFICATION

Class of classification according to ANVISA

Class II

Class of classification according to CE/FDA

Class I

Equipment classification according to EN IEC 60601-1

Product classification for applied parts - Type B
Protection Against Electric Shock - Class I

Protection Against Harmful Water Penetration

IP00 - Product not protected against harmful penetration of water and particulate matter

Degree of safety of application in the presence of a flammable anesthetic mixture with air or with oxygen or nitrous oxide

Unsuitable equipment

Operating Mode

Non-continuous operation

Handpieces

Operating Time:

Ton: 1 min. / Toff: 4 min.

10.2. APPLIANCE INFORMATION (GENERAL)

Supply mains voltage (from the chair)

24 V~

Power supply frequency

50 / 60 Hz

Allowable fluctuation

+/- 10 %

Power consumption

30 VA

Equipo net weight

26 kg

Equipo gross weight

31 kg

10.3.SPECIFIC INFORMATION

Air pressure (from the chair)

80 PSI (5.52 BAR)

Air input pressure Syringe

40 PSI (2.76 BAR)

Maximum air consumption (from the chair)

80 L/min

Water tank capacity (from the water unit)

1000 ml

High speed air consumption

32 L/min

High speed water consumption

42 mL/min

Syringe air consumption

17 L/min

Syringe water consumption

100 mL/min

Maximum load capacity applied to the tray holder

1 kg

Dimensional tray holder

385 x 300 mm

10.4.LED CURING LIGHT SPECIFICATION

Power

5.2 VA

Light source

1 LED

Active medium

Semiconductor LED (InGaN)

Wavelength

440nm – 460nm

Timer

60 seconds

10.5. ULTRASOUND SPECIFICATIONS

Ultrasound Vibration Frequency

29,000 Hz

Consumption of irrigating liquid

28 ml/min

Power consumed

15 VA

Transducer system

Electric piezo ceramic

10.6. ENVIRONMENTAL CONDITIONS

Environmental Conditions for Transportation and Storage

Transport or storage ambient temperature range

-12°C to + 50°C

Transport and storage relative humidity range

< 85% RH

Atmospheric pressure range

700 hPa to 1060 hPa
(525 mmHg to 795 mmHg)

Environmental installation and operating conditions

Ambient operating temperature range

+ 10°C to + 35°C

Operating relative humidity range (non-condensing)

< 75% RH

Atmospheric pressure range

700 hPa to 1060 hPa
(525 mmHg to 795 mmHg)

Operating altitude

≤ 2000 m

10.7.EQUIPMENT DIMENSIONS

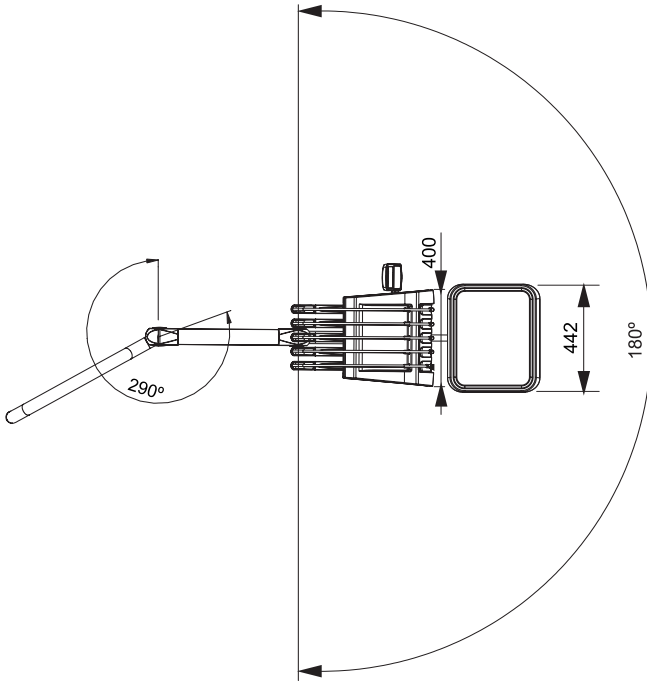
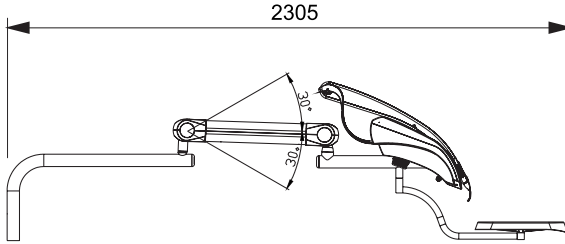

ELECTROMAGNETIC COMPATIBILITY

11. ELECTROMAGNETIC COMPATIBILITY

The Delivery Unit are intended for use in the electromagnetic environment specified below. The buyer or user should ensure that it is used in such an environment.

The Delivery Unit are suitable for use in a professional health care environment, not including areas where sensitive equipment or sources of intense electromagnetic disturbances are present, such as the RF shielded room of a magnetic resonance imaging system in operating rooms close to active AF surgical equipment, electrophysiology laboratories, armored rooms or areas where short wave therapy equipment is used.

The following tables provide information on the equipment's compliance with the ABNT NBR IEC 60601-1-2: 2017 standard.

11.1. ORIENTATION AND DECLARATION FOR ELECTROMAGNETIC EMISSIONS

Emission test	Compliance	Electromagnetic Environments - guidelines
RF emissions CISPR 11	Group 1	The Delivery Unit use RF energy only for their internal functions. Therefore, their RF emissions are very low and are not likely to cause any interference in nearby electronic equipment.
RF emissions CISPR 11	Class A	
Harmonic emissions IEC 61000-3-2	Class A	The Delivery Unit are suitable for use in all establishments except domestic and those directly connected to the public low voltage power supply network that powers buildings used for domestic purposes.
Voltage fluctuations/flicker emissions IEC 61000-3-3	Complies	

Note: The emission characteristics of this equipment make it suitable for use in industrial areas and hospitals (IEC/CISPR 11, Class A). If used in a residential environment (for which IEC/CISPR 11, Class B is normally required), this equipment may not provide adequate protection for radio frequency communication services. The user might need to take mitigation measures, such as relocating or re-orienting the equipment.

11.2.ORIENTATION AND DECLARATION FOR ELECTROMAGNETIC IMMUNITY

Phenomenon	Basic EMC standard or test method	Immunity test level	Compliance level
Electrostatic discharge	IEC 61000-4-2	± 8 kV contact ± 2 kV, ± 4 kV, ± 8 kV, ± 15 kV air	± 8 kV contact ± 2 kV, ± 4 kV, ± 8 kV, ± 15 kV air
Irradiated RF EM fields	IEC 61000-4-3	3 V/m 80 MHz - 2.7 GHz 80 % AM at 1 kHz	3 V/m 80 MHz – 2,7 GHz 80 % AM a 1 kHz
Fields in proximity from RF wireless communications equipment	IEC 61000-4-3	See Table	See Table
Fast / saved electrical transients	IEC 61000-4-4 AC power input	± 2 kV 100 kHz repeat frequency	± 2 kV 100 kHz repeat frequency
	IEC 61000-4-4 signal input/output	± 1 kV 100 kHz repeat frequency	± 1 kV 100 kHz repeat frequency
Line-to-line Outbreak	IEC 61000-4-5	± 0.5 kV, ± 1 kV	± 0.5 kV, ± 1 kV
Ground-Line Outbreak	IEC 61000-4-5	± 0.5 kV, ± 1 kV, ± 2 kV	± 0.5 kV, ± 1 kV, ± 2 kV
Conducted disturbances induced by RF fields	IEC 61000-4-6	3 V 0.15 MHz - 80 MHz 6V in ISM bands between 0.15 MHz and 80 MHz 80% AM at 1 kHz	3 V 0.15 MHz - 80 MHz 6V in ISM bands between 0.15 MHz and 80 MHz 80 % AM at 1 kHz
Magnetic fields at declared power frequency	IEC 61000-4-8	30 A/m 50 Hz or 60 Hz	30 A/m 50 Hz or 60 Hz
Voltage dips	IEC 61000-4-11	0 % UT; 0.5 cycle At 0°, 45°, 90°, 135°, 180°, 225°, 270° and 315° 0 % UT; 1 cycle and 70% UT; 25/30 cycles Single phase: at 0°	0 % UT; 0.5 cycle At 0°, 45°, 90°, 135°, 180°, 225°, 270° and 315° 0 % UT; 1 cycle and 70 % UT; 25/30 cycles Single phase: at 0°
Voltage interruptions	IEC 61000-4-11	0% UT; 250/300 cycles	The device will turn off and/or reboot if power is interrupted for five seconds.

NOTE 1 At 80 MHz and 800MHz, the highest frequency range is applicable.

NOTE 2 These guidelines may not apply in all situations. Electromagnetic propagation is affected by absorption and reflection from structures, objects and people.

NOTE 3 UT is the voltage of the AC electrical network before the application of the test level.

Proximity fields from wireless RF communications equipment

Test frequency (MHz)	Band (MHz)	Service	Modulation	Maximum Power (W)	Distance (m)	Immunity test level (V/m)
385	380-390	TETRA 400	Pulse modulation 18Hz	1.8	0.3	27
450	430-470	GMRS 460, FRS 460	FM deviation of \pm 5 kHz Sinoidal of 1kHz	2	0.3	28
710 745 7480	704-787	LTE Band 13, 17	Pulse modulation 217Hz	0.2	0.3	9
810 870 930	800-960	GSM 800/ 900, TETRA 800, iDEN 820, CDMA 850, LTE Band 5	Pulse modulation 18Hz	2	0.3	28
1720 1845 1970	1700 -1990	GSM 1800; CDMA 1900; GSM 1900; DECT; LTE band 1, 3, 4, 25; UMTS	Pulse modulation 217Hz	2	0.3	28
2450	2400-2570	Bluetooth, WLAN 802.11 b/g/n, RFID 2450, LTE Band 7	Pulse modulation 217Hz	2	0.3	28
5240 5500 5785	5100 - 5800	WLAN 802.11 a/n	Pulse modulation 217Hz	0.2	0.3	9

List of used cables

Cables	Description	Width
Power Supply	Tripolar Power Cable Gauge 3x 2.50 mm ² , 250V AC, Male Plug 20A NBR 14136 2P+T, no female plug, Inmetro.	3 m

	The Delivery Unit are intended to assist health professionals, and it is for dental use only. In case of EMC disturbances the operator may experience loss of communication between the equipment and controls.
	Compliance with EMC and EMI standards cannot be guaranteed by the use of altered cables or cables that do not meet the same standards as the equipment has been validated.
	The use of this equipment adjacent to other equipment should be avoided as this may result in improper operation. If this use is necessary, it is advisable that this and other equipment be observed to verify that they are operating normally.
	Do not use accessories, transducers, internal parts of components and other cables other than those previously specified by the manufacturer. This may result in increased emission or decreased electromagnetic immunity and result in improper operation.
	Portable RF communication equipment (including peripherals such as antenna cables and external antennas) should not be used less than 30 cm from any part of the equipment, including cables specified by the manufacturer. Otherwise, performance degradation of this equipment may occur.
	To maintain basic safety against electromagnetic disturbances during the expected service life, always use the equipment in the specified electromagnetic environment and follow the maintenance recommendation described in this manual.
	Pins, connector sockets, or elements bearing the ESD warning symbol must not be touched or interconnected without ESD protection measures.



CINTERQUAL - Soluções de
Comércio Internacional, Lda.
Avenida Defensores de Chaves, Nº 4
Escritório Idea Spaces
1000-117 Lisboa, Portugal

NUM. REG. ANVISA: 10069210075

